



# USER MANUAL

EV Charging Station

Version B: Basic

Read all instructions before using, operating, or maintaining.

# CONTENTS

## 1 Product Safety Information

1.1 Legal Notices	1
1.2 Safety Instructions	1
1.3 Connector Recommendations	2
1.4 Meanings of Related Symbols	2
1.5 Specified Use	3
1.6 About this Manual	3
1.7 Packing List	4

## 2 Product Overview

2.1 Product Decomposition	5
2.2 Specifications	6
2.3 Indicator Light Status	6
2.4 Introduction for Touching Key	7
2.5 Display Screen	8
2.6 Display Screen Introduction	9
2.7 Setting Page Introduction	10
2.8 Charging Failure	12

## 3 Operating Instructions

3.1 Start Charging	13
3.2 Stop Charging	13

## 4 Installation Instructions

4.1 Power Requirements	14
4.2 Environmental Requirements	14
4.3 Device Installation	15
4.4 Post Installation Inspection	21

## **5 Routine Maintenance**

5.1 Maintenance Period	22
5.2 Risk-Informed	22
<b>6 Frequently Asked Questions</b>	<b>23</b>
<b>7 Quality Assurance</b>	<b>24</b>

# 1 Product Safety Information

## 1.1 Legal Notices

This document is intended to be used as a reference guide for charging station installation and operation. The product images shown are for illustration only and may be different from the actual product. Charging Station reserves the right to change product specifications, processes and documents at any time without prior notice.





## 1.2 Safety Instructions

- It is not recommended to use the device to charge in rainy days due to safe electricity use regulations.
- Protect your device from any potential impact.
- Please do not step on the charging cable, pull the cable, bend or knot the cable.
- Do not use the charging pile under harsh conditions that affect the car or the charging pile equipment.
- Limited to electric vehicle charging.
- If physical defects such as cracks, damage, corrosion or other damage are found, please do not operate, and then contact your dealer.
- This device does not contain user-serviceable parts, please do not try to repair and maintain by yourself. Only authorized professionals can open, disassemble, repair, change or modify it.
- The manufacturer does not undertake the warranty obligation for the Charging station equipment modified without authorization.
- If the device cannot be charged normally according to the operation manual, please contact the dealer.
- Only used in the environment with RCD circuit breaker at the power supply end.
- The operating temperature of the device should not exceed -20°C to +55°C.
- Charging pile device must be well grounded.
- It is strictly prohibited to place the Charging station near the object generating high temperature during charging.
- Do not put your fingers into the charging plug.

## 1.3 Connector Recommendations

- Ensure to check the charging cable and contacts for damage and contamination before using.
- Do not use damaged charging cable, car plug or infrastructure power outlet to charge.
- Do not use dirty or wet contacts.
- Keep children away from the power cord.
- Do not trample on connectors or wires.
- Do not pull the wire under any circumstances when it is connected to the car.
- Some cars can be started after connecting to the charging pile, please be sure to unplug the vehicle connector before driving.

## 1.4 Meaning of Related Symbols

Symbol	Meaning
 Warning	<p><b>The "warning" sign indicates danger.</b></p> <p>Please be aware that failure to follow the operating instructions correctly may result in personal injury or device. This deciver is only intended for use with compatible electric vehicles and does not contain parts that can be repaired by the user.</p>
 Caution	<p><b>The "caution" sign indicates danger.</b></p> <p>Do not use if the vehicle connector or cable is damaged. Wait for the device indicator to enter normal charging mode before using.</p>
 Flame	<p><b>The "flame" sign indicates that caution should be taken to prevent fire.</b></p> <p>Please use this device with RCD protection. Misuse can cause electrical shock and fire hazards.</p>
 Water drop	<p><b>The "water drop" sign indicates that waterproofing should be taken note of.</b></p> <p>When charging, try to avoid exposing the charging gun to rain to avoid unnecessary damage.</p>
 Trash can	<p><b>The "trash can" sign indicates that the material is recyclable and should be separated from household waste.</b></p> <p>This sign is on the product, instructions, or packaging to indicate that electrical and electronic equipment and accessories should be treated separately from regular household waste. The material can be reused according to its label, and the reuse, material use or other forms of reuse of old device can make significant contributions to the environment.</p>

## 1.5 Specified Use

- ① This device is a wall charger for charging electric vehicles in indoor and outdoor areas.
- ② Please observed the regulations of each country when installing and connecting the charging station.
- ③ In any case, the specified use of the device shall be subject to the environmental conditions established for the equipment.
- ④ The device is developed, produced, inspected and filed according to relevant safety standards. Therefore, you shall be strictly followed the relevant instructions in the manual, and the device will not cause property or human health damage under normal conditions.
- ⑤ The instructions contained in this manual must be strictly followed, otherwise there may be potential safety hazards or failure of safety devices. Although the relevant safety instructions are described in this manual, the safety and accident prevention regulations applicable to the respective application must be observed.
- ⑥ All models/accessories cannot be supplied to all the countries and regions due to technical or legal restrictions.

## 1.6 About this Manual

**This manual is applicable to the device type:** AC charging station

**This manual is suitable for the following groups:**

End customers (wall charger users).

Commissioning, service technician.

Users must read and fully understand the safety instructions provided.

Please follow all safety instructions and take special care to keep the manual .  
This installation manual is intended for use by suitably qualified personnel only.

This manual contains safety information and instructions, and relevant information is also printed on the device. Ignoring and violating the above information may cause electric shock, fire or serious injury, and damage to the car or wall charger device. Any damage caused by this is not covered by the warranty. Wall charger device must be installed by qualified electricians under strict supervision. In addition to the information provided in this installation guide, users must also comply with all codes, standards or local regulations.

## 1.7 Packing List

<b>Ltem</b>	<b>Material name</b>	<b>Quantity</b>
1	Plug holder + Cable holder	1
2	Screws for holders	4
3	Wall charger	1
4	Charger holder	1
5	Screws for wall charger	4
6	Screws for fixing charging pile and holder	3
7	Packing box	1

## 2 Product Overview

### 2.1 Product Decomposition





## 2.2 Specifications

Compliant with Standards	IEC61851		
Rated Power	7kw (Max)	11kw (Max)	22kw (Max)
Output Current	6A~32A (Max)	6A~16A (Max)	6A~32A (Max)
Input Voltage	110V~230V AC±10% / 32A	380V AC±10% / 16A	380V AC±10% / 32A
Input Voltage	110V~230V AC±10% (1P)	380V AC±10% (3P)	380V AC±10% (3P)
Rated Frequency	50Hz/60Hz		
Operating Ambient Temperature	-20°C ~ +55°C		
Storage Temperature	-40°C ~ +80°C		
Protection Grade	Control Box: IP66, when plug is mated with vehicle, IP55		
Working humidity	5%~95%RH (No Condensation)		
Installation Methods	Pillar/Wall Mounted		
Charger Version	version B: Basic version		

## 2.3 Indicator Light Status





Mode	Indicator Light Status	Mode	Indicator Light Status
Ready	Green	Charging	Colorful Lights Flash
Swipe	Blue Flash (Only RFID Card Version, Basic Load Balancing Version)	Error	Red Flash
EV Connected	Green Flash	When Touching	Yellow
When Swiping	Purple	Reservation Charging	Blue

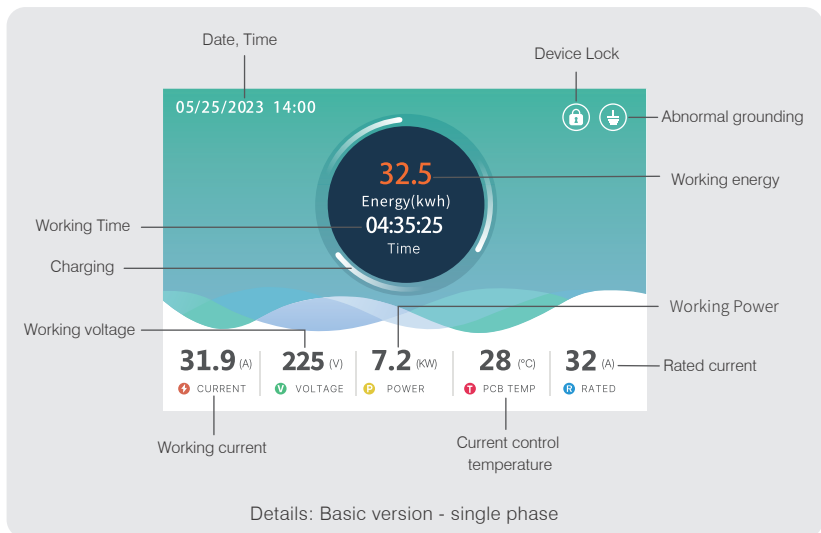
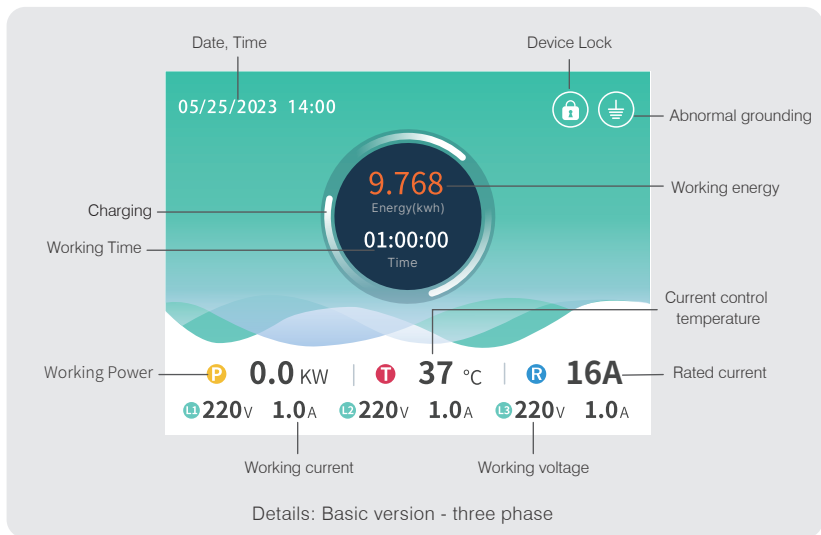

## 2.5 Display Screen





## 2.6 Display Screen Introduction

	 <p>Connecting</p>	<p>When the charging device is powered on but not connected to the vehicle, the  Please connect status icon will be displayed on the upper right corner of the device screen.</p>
	 <p>Waiting for the vehicle to respond</p>	<p>When the connector is connected to the vehicle, the vehicle does not respond or the car is fully charged (already to the battery level setting), the upper right corner of the device screen will display  Waiting for the vehicle to respond to the icon.</p>
	<p>Time set</p>	<p>The device is unlocked in the charging state, touch the middle button to enter for 1 hour. Appointment countdown; appointment charging can provide 1-12 hours of appointment charging Electric setting.</p>
	<p>Reserve charging</p>	<ol style="list-style-type: none"> <li>1. Charging timer on, " " displayed on the upper right corner.</li> <li>2. Plug into car, charging timer begins.</li> </ol> <p>Basic version: charging immediately by turning off this function on the settings page. Note : It is the schedule daily charging after setting.</p>
	<p>Charging</p>	<p>When the device is charging, the display interface displays a rotating animation.</p>

## 2.7 Setting Page Introduction

The charging device has been connected to the power

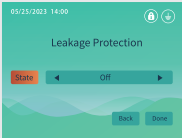
	<p>Charging record</p>	<p>Enter the [Charging Records] page, Max 30 records can be saved, through. Left key, right key and middle key (confirm key) to view. Note: After accumulating 30 charging records, the new record will start from the earliest record for loop coverage.</p>
	<p>Date setting Time setting</p>	<p>Enter the [Date Setting] page, Click Right button ↻ / left button to select [Y] [M] [D]], Click Middle button ⏺ to set. Select [Next] , click to Middle button ⏺ to enter [Time Setting]. Click Right button ↻ / left button ↻ to select [H] [M ], Click Middle button ⏺ to set. Select [Done] , click to Middle button ⏺ to save the setting.</p>
	<p>Screen brightness</p>	<p>Enter the [Screen Brightness] page, you can use the left button, right button and middle button to (confirm key) to adjust the brightness of 1-6 levels.</p>

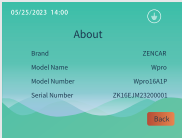
	<p><b>Leakage Protection</b></p>	<p>Enter the interface [Leakage Protection], set the leakage protection [on], [off] by clicking the left button, right button and middle button (confirmation button).</p>
	<p><b>Reserve charging</b></p>	<p>Enter the [Reserve Charging] page, Use Right button  ▶ / Left button ◀ / Middle button ● to set reserve charging time.</p>
	<p><b>Device Information</b></p>	<p>Enter the [Device Information] page to view the device information.</p>

## 2.8 Charging Failure

When an error occurs on the device, it pops up with the corresponding error code.

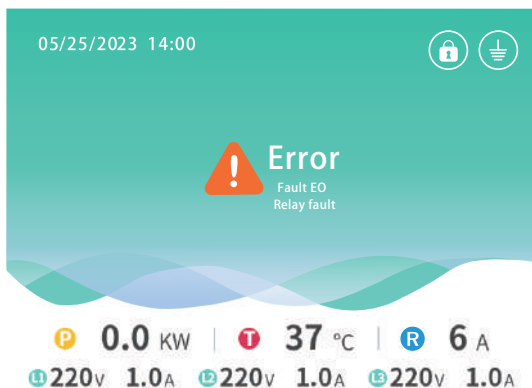

Figure 2-5 Error code details

E0	Relay fault
E1	RCD self-test exception
E2	Under voltage protection
E3	Over voltage protection
E4	Leakage protection (Leakage protection activated)
E5	Over current protection
E6	PCB over temperature protection
E9	CP fault
E10	Ground protection
E12	Short circuit protection

# 3 Operating Instructions

## 3.1 Start Charging

- 1、 The charging device is power on but not plug into car end, the charging pile is in standby state;
- 2、 Plugin to car, start charging



## 3.2 Stop Charging

Operating steps:

- ① Do not use brute force to pull out the mechanically locked car plug from the car end,
- ② Unlock vehicle, press the button of charging plug and pull out from vehicle socket.
- ③ Pull out the charging plug and plug into the holders.



Figure 3-3 Stop charging



## 4 Installation Instructions

### 4.1 Power Requirements

The power supply mode of the wall charge is AC single-phase and three-phase power supply, and the input electrical requirements are:

- ① AC working voltage: AC 110V~230V $\pm$ 10% (single-phase); AC 380V $\pm$ 10% (three-phase)
- ② AC working frequency: 50Hz/60Hz

### 4.2 Environmental Requirements

- ① Working environment temperature: -20°C~+55°C
- ② Relative humidity: 5% to 95%
- ③ Installation vertical inclination:  $\leq$ 5%
- ④ There is no strong vibration and shock at the place of use, and no strong electro magnetic interference.

### 4.3 Device Installation (self installation for reference only)

- ① Tool Listing (The device does not include the tool listing, please prepare them by yourself)  
Electric drill, tape measure, a set of Torx screwdriver, marker pen, adhesive tape, tool hammer, outer hex.



Figure 4-2 Tool Listing

- ② Wall Charger  
General Installation Drawing



Figure 4-3 General Installation Drawing

Please confirm the installation position and mark it. The bottom of the wall charger should be at least 1.2~1.5m above the ground, as shown in Figure 4-4.

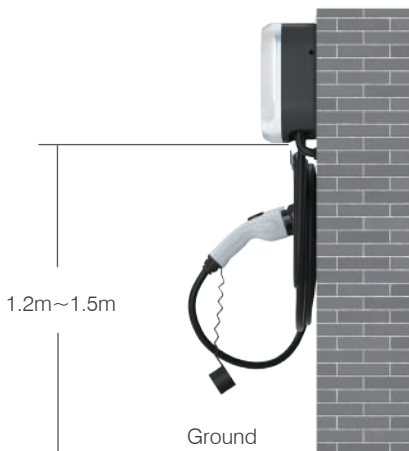

Figure 4-4 Wall Installation Height

Mark the hole position on the wall where the equipment needs to be installed with a marker pen (using punching positioning paper to assist in marking), as shown in

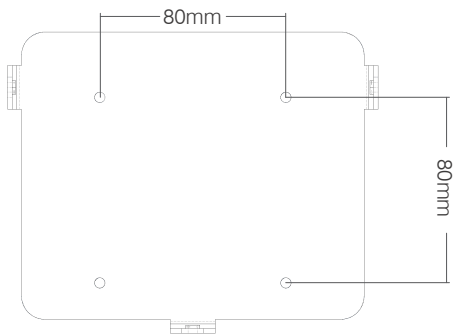

Figure 4-5 Mark Hole Position

Use an electric drill with a drill bit  $\phi 6$  to drill 50mm deep hole, insert 4pcs expansion tubes, place the charger holder and drive in 4pcs self-tapping screws, as shown in Figure 4-6.

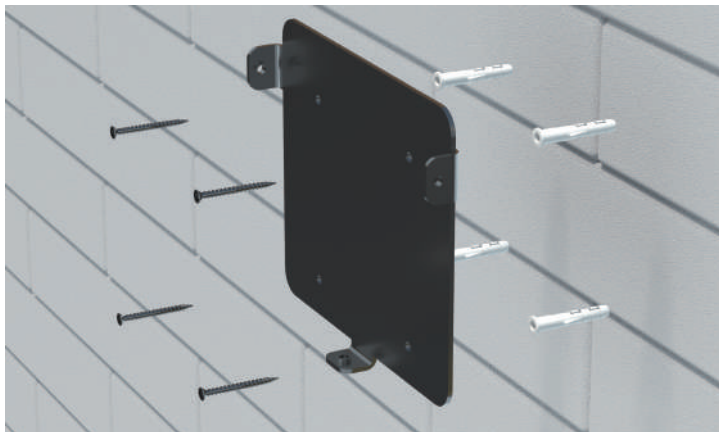

Figure 4-6 Install the charger holder

Align the three holes on the back of the charger with the three fixing points on the charger holder, and fix charger with 3pcs screws after hanging, as shown in Figure 4-7.



Figure 4-7 Fix the charger to the charger holder

Wall-mounted charger is installed successfully, as shown in Figure 4-8.



Figure 4-8 Installation completed

③ Pillar charging station  
General Installation Drawing



Figure 4-9 General Installation Drawing

## Pillar Installation

Use M8\*72 expansion screws to fasten the pillar to the ground, as shown in Figure 4-10.



Figure 4-10 Pillar Installation

## Holders Installation

Fix charger holder, cable holder and plug holder to the pillar, as shown on Figure 4-11.

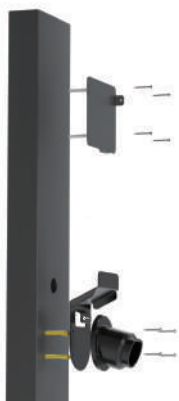

Figure 4-11 Holders Installation

Align the three holes on the back of the charger with the three fixing points on the charger holder, and fix charger with 3pcs screws after hanging.



as shown in Figure 4-12

Pillar charger is installed successfully, as shown in Figure 4-13.



Figure 4-13 Installation completed

#### ④ Switch (Circuit breaker) Installation

- A. Clip the circuit breaker into the guide rail inside the electrical box or pillar.
- B. The external power cord is connected to the inlet side of the circuit breaker.
- C. Thread the power cord of the equipment into the protective coil hole on the electrical box or pillar, then connect it to the outlet side of the circuit breaker.
- D. The ground wire is reliably connected to the ground wire of the power supply system nearby. (Notice: 1. This grounding wire is strictly prohibited from being connected to any circuit breaker, such as fuses, air switches, knife switches, toggle switches etc; 2. The grounding wire must be equipped with a sufficiently large copper medal.)
- E. The diagram is for reference only. Please refer to the circuit breaker wiring instructions for specific inlet and outlet methods.

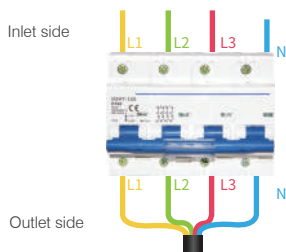

Figure 4-14 3P Circuit Breaker  
Schematic diagram of access method

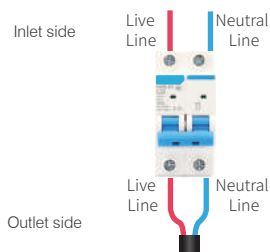

Figure 4-15 Single Phase Circuit Breaker  
Schematic diagram of access method

## 4.4 Post Installation Inspection

### ① Cleaning

Properly dispose of all transportation and packaging materials in accordance with local regulations. Clean up the sundries around the Charging station, such as small cables, binding tapes, nuts etc. Do not leave installation tools on the site (record the type and quantity of tools to prevent omission). Wipe the insulating part with an antistatic cloth, and do not use any corrosive solvents.

### ② Inspection

Check if the base is fixed and sealed.

Check whether the electrical connections and wiring are correct and complete, whether the connections are secure and the grounding is reliable.

Check whether the protection level of the equipment meets the requirements, especially at the cable inlet at the bottom of the charging station. View appearance, marking, integrity, cleanliness.



# 5 Routine Maintenance

## 5.1 Maintenance Period

The following routine maintenance items are for reference only, please refer to relevant standards and work instructions for operation.

Inspection items	Period	Solution
Vehicle side Connector Plug	Per Week	Cleaning
Device Appearance	Per Month	Cleaning

## 5.2 Risk-Informed

- ① Only trained, qualified, and authorized professionals are allowed to install the charging station.
- ② It is necessary to regularly check the vehicle side connector plug cable and the shell of the wall charger are damaged(visual inspections).
- ③ Please switch off the wall charger immediately and contact the manufacturer if the wall charger damaged.
- ④ Do not modify, alter, relocate or modify the wall charger or circuit.
- ⑤ Do not remove safety signs, warning signs, nameplates, or pipe markers.
- ⑥ Do not use any extension cables when connecting an electric vehicle to the charging device.
- ⑦ Only connect electric vehicles or its charging equipment, do not connect other loads (such as power tools).
- ⑧ Please hold the connector plug when pulling out the connector plug, do not pull the cable.
- ⑨ Do not bend, squeeze or roll the vehicle-side connector plug, which may cause mechanical damage.
- ⑩ Do not let the contact surface of the vehicle-side connector plug contact heat sources, dirt or water sources.
- ⑪ Indoor charging should be equipped with external ventilation systems.
- ⑫ Do not use sprays (garden hoses, high-pressure cleaners, etc.) to clean the charging station.  
Do not allow Children stay around the charging device to prevent the risk of electric shock.
- ⑬ Please read carefully the relevant tips and instructions of the vehicle when using the wall charger to
- ⑭ charge an electric vehicle.

## 6 Frequently Asked Questions

### 1. The power light is off:

Check the leakage protection next to the charging pile and other leakage protection on the line and whether the ammeter is tripped or in arrears. If the air switch trips and fails, please close the air switch under the condition of ensuring safety. Please recharge the meter in arrears or renew the guarantee powered by.

### 2. Unable to start charging process:

Check whether the car-end connector plug is inserted into the vehicle correctly, you can try to unplug the car-end connector plug again, hold the handle of the car-end connector plug with one hand (no need to press the unlock button), plug it into the vehicle charging socket, and hear "Ka-Da" Voice. Check whether the vehicle is set for scheduled charging or other function settings that affect charging, and try to start charging again after shutting down.

### 3. The fault status light turns red:

Try to power off and restart the Charging station, and observe whether the fault light is eliminated.

## 7 Quality Assurance

Zencar wall charger warranted that all the wall chargers are with strict quality inspection and will provide maintenance for product problems caused by correct use within 1 year from the date of shipment.

### **This warranty do not cover any damage due to the following cases:**

1. Improper handling, installation, use and maintenance by users.
2. The break down and the failure caused by the force majeure, such as direct damage and inability to function properly caused by natural disasters.
3. Products are filled with water or soaked in water.

This warranty does not include the cost of returning to the factory for repair.

This warranty is only valid to the original purchaser of the device and is not transferable.



## **Shanghai Zencar Industry Co., Ltd.**

Tel: +86-519-68783066

Fax: +86-519-68783077

Web: [www.zencar.net](http://www.zencar.net)

Add: No.712, Building 2, No.518 Liaohe Road, Xinbei, Changzhou, Jiangsu, China 213022