

SUN2000-(90KTL, 95KTL, 100KTL, 105KTL) Series

User Manual

Issue 16
Date 2023-12-20



Copyright © Huawei Technologies Co., Ltd. 2024. All rights reserved.

No part of this document may be reproduced or transmitted in any form or by any means without prior written consent of Huawei Technologies Co., Ltd.

Trademarks and Permissions



HUAWEI and other Huawei trademarks are trademarks of Huawei Technologies Co., Ltd.

All other trademarks and trade names mentioned in this document are the property of their respective holders.

Notice

The purchased products, services and features are stipulated by the contract made between Huawei and the customer. All or part of the products, services and features described in this document may not be within the purchase scope or the usage scope. Unless otherwise specified in the contract, all statements, information, and recommendations in this document are provided "AS IS" without warranties, guarantees or representations of any kind, either express or implied.

The information in this document is subject to change without notice. Every effort has been made in the preparation of this document to ensure accuracy of the contents, but all statements, information, and recommendations in this document do not constitute a warranty of any kind, express or implied.

Huawei Technologies Co., Ltd.

Address: Huawei Industrial Base
Bantian, Longgang
Shenzhen 518129
People's Republic of China

Website: <https://e.huawei.com>

About This Document

Purpose



This document describes the SUN2000-90KTL-H0, SUN2000-90KTL-H1, SUN2000-90KTL-H2, SUN2000-95KTL-INH0, SUN2000-95KTL-INH1, SUN2000-100KTL-H0, SUN2000-100KTL-H1, SUN2000-100KTL-H2, and SUN2000-105KTL-H1 (SUN2000 for short) in terms of their installation, electrical connections, commissioning, maintenance, and troubleshooting. Before installing and operating the SUN2000, ensure that you are familiar with the features, functions, and safety precautions provided in this document.



Intended Audience

This document is intended for photovoltaic (PV) power plant personnel and qualified electrical technicians.

Symbol Conventions

The symbols that may be found in this document are defined as follows.

Symbol	Remarks
 DANGER	Indicates a hazard with a high level of risk which, if not avoided, will result in death or serious injury.
 WARNING	Indicates a hazard with a medium level of risk which, if not avoided, could result in death or serious injury.
 CAUTION	Indicates a hazard with a low level of risk which, if not avoided, could result in minor or moderate injury.

Symbol	Remarks
 NOTICE	Indicates a potentially hazardous situation which, if not avoided, could result in equipment damage, data loss, performance deterioration, or unanticipated results. NOTICE is used to address practices not related to personal injury.
 NOTE	Supplements the important information in the main text. NOTE is used to address information not related to personal injury, equipment damage, and environment deterioration.

Change History

Changes between document issues are cumulative. The latest document issue contains all updates made in previous issues.

Issue 16 (2023-12-20)

Updated [4.3 Determining the Installation Position](#).

Updated [5.2.1 MBUS Communication](#).

Updated [8.4 Alarm Reference](#).

Issue 15 (2023-08-31)

Updated [2.3.3 Label Description](#).

Added [2.5 Smart I-V Curve Diagnosis](#).

Updated [C Contact Information](#).

Added [D Digital Power Customer Service](#).

Issue 14 (2023-05-25)

Updated [1 Safety Information](#).

Updated [2.2 Product Introduction](#).

Updated [4.1 Checking Before Installation](#).

Updated [5.1 Precautions](#).

Updated [5.5 Connecting an AC Output Power Cable](#).

Updated [6.2 Powering On the SUN2000](#).

Updated [8 Maintenance](#).

Issue 13 (2021-01-19)

Updated [B Grid Codes](#).

Issue 12 (2020-12-18)

Updated [5.2.1 MBUS Communication](#).

Issue 11 (2020-08-30)

Updated [2.2 Product Introduction](#).

Updated [4.3 Determining the Installation Position](#).

Updated [8.3 Routine Maintenance](#).

Issue 10 (2020-03-28)

Updated [4.5 Installing the SUN2000](#).

Updated [5.2 Preparing Cables](#).

Updated [5.6 Installing the DC Input Power Cable](#).

Updated [B Grid Codes](#).

Issue 09 (2020-02-18)

Updated [7.1 Operations with the SUN2000 App](#).

Updated [10 Technical Data](#).

Issue 08 (2019-12-18)

Updated [3 Storage](#).

Added [8.2 Power-Off for Troubleshooting](#).

Issue 07 (2019-07-17)

Updated [2.3.1 Appearance](#).

Updated [10 Technical Data](#).

Issue 06 (2019-06-27)

Updated [5.2.1 MBUS Communication](#).

Updated [7.1.3 Logging In to the App](#).

Issue 05 (2018-11-30)

Updated [5.8 \(Optional\) Installing the Power Cable of the Tracking System](#).

Issue 04 (2018-10-23)

Updated [2.2 Product Introduction](#).

Updated [10 Technical Data](#).

Issue 03 (2018-07-23)

Added description about the SUN2000-90KTL-H2, SUN2000-95KTL-INH1, SUN2000-100KTL-H2, and SUN2000-105KTL-H1 models.

Issue 02 (2018-06-23)

Updated [10 Technical Data](#).

Issue 01 (2018-05-17)

This issue is used for first office application (FOA).

Contents

About This Document.....	ii
1 Safety Information.....	1
1.1 Personal Safety.....	2
1.2 Electrical Safety.....	4
1.3 Environment Requirements.....	7
1.4 Mechanical Safety.....	8
2 Overview.....	13
2.1 Models.....	13
2.2 Product Introduction.....	15
2.3 Product Appearance.....	17
2.3.1 Appearance.....	17
2.3.2 Indicator Status.....	21
2.3.3 Label Description.....	23
2.4 Working Principles.....	24
2.4.1 Circuit Diagram.....	24
2.4.2 Working Modes.....	25
2.5 Smart I-V Curve Diagnosis.....	27
3 Storage.....	28
4 Installation.....	30
4.1 Checking Before Installation.....	30
4.2 Tool Preparation.....	30
4.3 Determining the Installation Position.....	32
4.4 Installing the Mounting Bracket.....	36
4.4.1 Support-Mounted Installation.....	37
4.4.2 Wall-Mounted Installation.....	38
4.5 Installing the SUN2000.....	39
5 Electrical Connections.....	44
5.1 Precautions.....	44
5.2 Preparing Cables.....	45
5.2.1 MBUS Communication.....	45
5.2.2 RS485 Communication.....	49

5.3 Installing the PE Cable.....	55
5.4 Opening the Maintenance Compartment Door.....	56
5.5 Connecting an AC Output Power Cable.....	57
5.6 Installing the DC Input Power Cable.....	61
5.7 Connecting the RS485 Communications Cable.....	64
5.8 (Optional) Installing the Power Cable of the Tracking System.....	67
5.9 Closing the Maintenance Compartment Door.....	69
6 Commissioning.....	71
6.1 Checking Before Power-On.....	71
6.2 Powering On the SUN2000.....	72
7 Man-Machine Interactions.....	73
7.1 Operations with the SUN2000 App.....	73
7.1.1 App Introduction.....	73
7.1.2 Downloading and Installing the App.....	74
7.1.3 Logging In to the App.....	75
7.1.4 Operations Related to the Advanced User.....	79
7.1.4.1 Setting Grid Parameters.....	79
7.1.4.2 Setting Protection Parameters.....	80
7.1.4.3 Setting Feature Parameters.....	80
7.1.5 Operations Related to the Special User.....	84
7.1.5.1 Setting Grid Parameters.....	85
7.1.5.2 Setting Protection Parameters.....	87
7.1.5.3 Setting Feature Parameters.....	89
7.1.5.4 Setting Power Adjustment Parameters.....	91
7.2 Operations with a USB Flash Drive.....	96
7.2.1 Exporting Configurations.....	96
7.2.2 Importing Configurations.....	98
7.2.3 Exporting Data.....	99
7.2.4 Upgrading.....	100
8 Maintenance.....	102
8.1 Powering Off the SUN2000.....	102
8.2 Power-Off for Troubleshooting.....	103
8.3 Routine Maintenance.....	104
8.4 Alarm Reference.....	105
9 Handling the Inverter.....	106
9.1 Removing the SUN2000.....	106
9.2 Packing the SUN2000.....	106
9.3 Disposing of the SUN2000.....	106
10 Technical Data.....	107
10.1 SUN2000-(90KTL, 95KTL) Series Technical Data.....	107

10.2 SUN2000-(100KTL, 105KTL) Series Technical Data.....	111
A Domain Name List of Management Systems.....	115
B Grid Codes.....	116
C Contact Information.....	126
D Digital Power Customer Service.....	128
E Acronyms and Abbreviations.....	129

1 Safety Information

Statement

Before transporting, storing, installing, operating, using, and/or maintaining the equipment, read this document, strictly follow the instructions provided herein, and follow all the safety instructions on the equipment and in this document. In this document, "equipment" refers to the products, software, components, spare parts, and/or services related to this document; "the Company" refers to the manufacturer (producer), seller, and/or service provider of the equipment; "you" refers to the entity that transports, stores, installs, operates, uses, and/or maintains the equipment.

The **Danger, Warning, Caution, and Notice** statements described in this document do not cover all the safety precautions. You also need to comply with relevant international, national, or regional standards and industry practices. **The Company shall not be liable for any consequences that may arise due to violations of safety requirements or safety standards concerning the design, production, and usage of the equipment.**

The equipment shall be used in an environment that meets the design specifications. Otherwise, the equipment may be faulty, malfunctioning, or damaged, which is not covered under the warranty. The Company shall not be liable for any property loss, personal injury, or even death caused thereby.

Comply with applicable laws, regulations, standards, and specifications during transportation, storage, installation, operation, use, and maintenance.

Do not perform reverse engineering, decompilation, disassembly, adaptation, implantation, or other derivative operations on the equipment software. Do not study the internal implementation logic of the equipment, obtain the source code of the equipment software, violate intellectual property rights, or disclose any of the performance test results of the equipment software.

The Company shall not be liable for any of the following circumstances or their consequences:

- The equipment is damaged due to force majeure such as earthquakes, floods, volcanic eruptions, debris flows, lightning strikes, fires, wars, armed conflicts, typhoons, hurricanes, tornadoes, and other extreme weather conditions.
- The equipment is operated beyond the conditions specified in this document.

- The equipment is installed or used in environments that do not comply with international, national, or regional standards.
- The equipment is installed or used by unqualified personnel.
- You fail to follow the operation instructions and safety precautions on the product and in the document.
- You remove or modify the product or modify the software code without authorization.
- You or a third party authorized by you cause the equipment damage during transportation.
- The equipment is damaged due to storage conditions that do not meet the requirements specified in the product document.
- You fail to prepare materials and tools that comply with local laws, regulations, and related standards.
- The equipment is damaged due to your or a third party's negligence, intentional breach, gross negligence, or improper operations, or other reasons not related to the Company.

1.1 Personal Safety

 **DANGER**

Ensure that power is off during installation. Do not install or remove a cable with power on. Transient contact between the core of the cable and the conductor will generate electric arcs or sparks, which may cause a fire or personal injury.

 **DANGER**

Non-standard and improper operations on the energized equipment may cause fire, electric shocks, or explosion, resulting in property damage, personal injury, or even death.

 **DANGER**

Before operations, remove conductive objects such as watches, bracelets, bangles, rings, and necklaces to prevent electric shocks.

 **DANGER**

During operations, use dedicated insulated tools to prevent electric shocks or short circuits. The dielectric withstanding voltage level must comply with local laws, regulations, standards, and specifications.

 **WARNING**

During operations, wear personal protective equipment such as protective clothing, insulated shoes, goggles, safety helmets, and insulated gloves.

Figure 1-1 Personal protective equipment

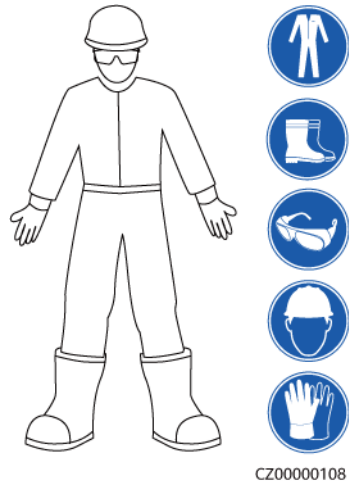

General Requirements

- Do not stop protective devices. Pay attention to the warnings, cautions, and related precautionary measures in this document and on the equipment.
- If there is a likelihood of personal injury or equipment damage during operations, immediately stop, report the case to the supervisor, and take feasible protective measures.
- Do not power on the equipment before it is installed or confirmed by professionals.
- Do not touch the power supply equipment directly or with conductors such as damp objects. Before touching any conductor surface or terminal, measure the voltage at the contact point to ensure that there is no risk of electric shock.
- Do not touch operating equipment because the enclosure is hot.
- Do not touch a running fan with your hands, components, screws, tools, or boards. Otherwise, personal injury or equipment damage may occur.
- In the case of a fire, immediately leave the building or the equipment area and activate the fire alarm or call emergency services. Do not enter the affected building or equipment area under any circumstances.

Personnel Requirements

- Only professionals and trained personnel are allowed to operate the equipment.
 - Professionals: personnel who are familiar with the working principles and structure of the equipment, trained or experienced in equipment operations and are clear of the sources and degree of various potential hazards in equipment installation, operation, maintenance

- Trained personnel: personnel who are trained in technology and safety, have required experience, are aware of possible hazards on themselves in certain operations, and are able to take protective measures to minimize the hazards on themselves and other people
- Personnel who plan to install or maintain the equipment must receive adequate training, be able to correctly perform all operations, and understand all necessary safety precautions and local relevant standards.
- Only qualified professionals or trained personnel are allowed to install, operate, and maintain the equipment.
- Only qualified professionals are allowed to remove safety facilities and inspect the equipment.
- Personnel who will perform special tasks such as electrical operations, working at heights, and operations of special equipment must possess the required local qualifications.
- Only authorized professionals are allowed to replace the equipment or components (including software).
- Only personnel who need to work on the equipment are allowed to access the equipment.

1.2 Electrical Safety

 **DANGER**

Before connecting cables, ensure that the equipment is intact. Otherwise, electric shocks or fire may occur.

 **DANGER**

Non-standard and improper operations may result in fire or electric shocks.

 **DANGER**

Prevent foreign matter from entering the equipment during operations. Otherwise, equipment damage, load power derating, power failure, or personal injury may occur.

 **WARNING**

For the equipment that needs to be grounded, install the ground cable first when installing the equipment and remove the ground cable last when removing the equipment.

WARNING

During the installation of PV strings and the SUN2000, the positive or negative terminals of PV strings may be short-circuited to ground if the power cables are not properly installed or routed. In this case, an AC or DC short circuit may occur and damage the SUN2000. The resulting device damage is not covered under any warranty.

CAUTION

Do not route cables near the air intake or exhaust vents of the equipment.

General Requirements

- Follow the procedures described in the document for installation, operation, and maintenance. Do not reconstruct or alter the equipment, add components, or change the installation sequence without permission.
- Obtain approval from the national or local electric utility company before connecting the equipment to the grid.
- Observe the power plant safety regulations, such as the operation and work ticket mechanisms.
- Install temporary fences or warning ropes and hang "No Entry" signs around the operation area to keep unauthorized personnel away from the area.
- Before installing or removing power cables, turn off the switches of the equipment and its upstream and downstream switches.
- Before performing operations on the equipment, check that all tools meet the requirements and record the tools. After the operations are complete, collect all of the tools to prevent them from being left inside the equipment.
- Before installing power cables, check that cable labels are correct and cable terminals are insulated.
- When installing the equipment, use a torque tool of a proper measurement range to tighten the screws. When using a wrench to tighten the screws, ensure that the wrench does not tilt and the torque error does not exceed 10% of the specified value.
- Ensure that bolts are tightened with a torque tool and marked in red and blue after double-check. Installation personnel mark tightened bolts in blue. Quality inspection personnel confirm that the bolts are tightened and then mark them in red. (The marks must cross the edges of the bolts.)

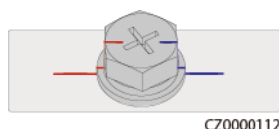

- If the equipment has multiple inputs, disconnect all the inputs before operating the equipment.
- Before maintaining a downstream electrical or power distribution device, turn off the output switch on the power supply equipment.

- During equipment maintenance, attach "Do not switch on" labels near the upstream and downstream switches or circuit breakers as well as warning signs to prevent accidental connection. The equipment can be powered on only after troubleshooting is complete.
- Do not open equipment panels.
- Check equipment connections periodically, ensuring that all screws are securely tightened.
- Only qualified professionals can replace a damaged cable.
- Do not scrawl, damage, or block any labels or nameplates on the equipment. Promptly replace labels that have worn out.
- Do not use solvents such as water, alcohol, or oil to clean electrical components inside or outside of the equipment.

Grounding

- Ensure that the grounding impedance of the equipment complies with local electrical standards.
- Ensure that the equipment is connected permanently to the protective ground. Before operating the equipment, check its electrical connection to ensure that it is reliably grounded.
- Do not work on the equipment in the absence of a properly installed ground conductor.
- Do not damage the ground conductor.

Cabling Requirements

- When selecting, installing, and routing cables, follow local safety regulations and rules.
- When routing power cables, ensure that there is no coiling or twisting. Do not join or weld power cables. If necessary, use a longer cable.
- Ensure that all cables are properly connected and insulated, and meet specifications.
- Ensure that the slots and holes for routing cables are free from sharp edges, and that the positions where cables are routed through pipes or cable holes are equipped with cushion materials to prevent the cables from being damaged by sharp edges or burrs.
- Ensure that cables of the same type are bound together neatly and straight and that the cable sheath is intact. When routing cables of different types, ensure that they are away from each other without entanglement and overlapping.
- Secure buried cables using cable supports and cable clips. Ensure that the cables in the backfill area are in close contact with the ground to prevent cable deformation or damage during backfilling.
- If the external conditions (such as the cable layout or ambient temperature) change, verify the cable usage in accordance with the IEC-60364-5-52 or local laws and regulations. For example, check that the current-carrying capacity meets requirements.
- When routing cables, reserve at least 30 mm clearance between the cables and heat-generating components or areas. This prevents deterioration or damage to the cable insulation layer.

1.3 Environment Requirements

 **DANGER**

Do not expose the equipment to flammable or explosive gas or smoke. Do not perform any operation on the equipment in such environments.

 **DANGER**

Do not store any flammable or explosive materials in the equipment area.

 **DANGER**

Do not place the equipment near heat sources or fire sources, such as smoke, candles, heaters, or other heating devices. Overheat may damage the equipment or cause a fire.

 **WARNING**

Install the equipment in an area far away from liquids. Do not install it under areas prone to condensation, such as under water pipes and air exhaust vents, or areas prone to water leakage, such as air conditioner vents, ventilation vents, or feeder windows of the equipment room. Ensure that no liquid enters the equipment to prevent faults or short circuits.

 **WARNING**

To prevent damage or fire due to high temperature, ensure that the ventilation vents or heat dissipation systems are not obstructed or covered by other objects while the equipment is running.

General Requirements

- Ensure that the equipment is stored in a clean, dry, and well ventilated area with proper temperature and humidity and is protected from dust and condensation.
- Keep the installation and operating environments of the equipment within the allowed ranges. Otherwise, its performance and safety will be compromised.
- Do not install, use, or operate outdoor equipment and cables (including but not limited to moving equipment, operating equipment and cables, inserting connectors to or removing connectors from signal ports connected to outdoor facilities, working at heights, performing outdoor installation, and opening

doors) in harsh weather conditions such as lightning, rain, snow, and level 6 or stronger wind.

- Do not install the equipment in an environment with dust, smoke, volatile or corrosive gases, infrared and other radiations, organic solvents, or salty air.
- Do not install the equipment in an environment with conductive metal or magnetic dust.
- Do not install the equipment in an area conducive to the growth of microorganisms such as fungus or mildew.
- Do not install the equipment in an area with strong vibration, noise, or electromagnetic interference.
- Ensure that the site complies with local laws, regulations, and related standards.
- Ensure that the ground in the installation environment is solid, free from spongy or soft soil, and not prone to subsidence. The site must not be located in a low-lying land prone to water or snow accumulation, and the horizontal level of the site must be above the highest water level of that area in history.
- Do not install the equipment in a position that may be submerged in water.
- If the equipment is installed in a place with abundant vegetation, in addition to routine weeding, harden the ground underneath the equipment using cement or gravel (the area shall be greater than or equal to 3 m x 2.5 m).
- Do not install the equipment outdoors in salt-affected areas because it may be corroded. A salt-affected area refers to the region within 500 m of the coast or prone to sea breeze. Regions prone to sea breeze vary with weather conditions (such as typhoons and monsoons) or terrains (such as dams and hills).
- Before installation, operation, and maintenance, clean up any water, ice, snow, or other foreign objects on the top of the equipment.
- When installing the equipment, ensure that the installation surface is solid enough to bear the weight of the equipment.
- After installing the equipment, remove the packing materials such as cartons, foam, plastics, and cable ties from the equipment area.

1.4 Mechanical Safety



Ensure that all necessary tools are ready and inspected by a professional organization. Do not use tools that have signs of scratches or fail to pass the inspection or whose inspection validity period has expired. Ensure that the tools are secure and not overloaded.

 **WARNING**

Do not drill holes into the equipment. Doing so may affect the sealing performance and electromagnetic containment of the equipment and damage components or cables inside. Metal shavings from drilling may short-circuit boards inside the equipment.

General Requirements

- Repaint any paint scratches caused during equipment transportation or installation in a timely manner. Equipment with scratches must not be exposed for an extended period of time.
- Do not perform operations such as arc welding and cutting on the equipment without evaluation by the Company.
- Do not install other devices on the top of the equipment without evaluation by the Company.
- When performing operations over the top of the equipment, take measures to protect the equipment against damage.
- Use correct tools and operate them in the correct way.

Moving Heavy Objects

- Be cautious to prevent injury when moving heavy objects.



< 18 kg
(< 40 lbs)



18–32 kg
(40–70 lbs)



32–55 kg
(70–121 lbs)

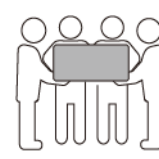

55–68 kg
(121–150 lbs)



> 68 kg
(> 150 lbs)

CZ0000110

- If multiple persons need to move a heavy object together, determine the manpower and work division with consideration of height and other conditions to ensure that the weight is equally distributed.
- If two persons or more move a heavy object together, ensure that the object is lifted and landed simultaneously and moved at a uniform pace under the supervision of one person.
- Wear personal protective gears such as protective gloves and shoes when manually moving the equipment.
- To move an object by hand, approach to the object, squat down, and then lift the object gently and stably by the force of the legs instead of your back. Do not lift it suddenly or turn your body around.
- Do not quickly lift a heavy object above your waist. Place the object on a workbench that is half-waist high or any other appropriate place, adjust the positions of your palms, and then lift it.
- Move a heavy object stably with balanced force at an even and low speed. Put down the object stably and slowly to prevent any collision or drop from scratching the surface of the equipment or damaging the components and cables.

- When moving a heavy object, be aware of the workbench, slope, staircase, and slippery places. When moving a heavy object through a door, ensure that the door is wide enough to move the object and avoid bumping or injury.
- When transferring a heavy object, move your feet instead of turning your waist around. When lifting and transferring a heavy object, ensure that your feet point to the target direction of movement.
- When transporting the equipment using a pallet truck or forklift, ensure that the tynes are properly positioned so that the equipment does not topple. Before moving the equipment, secure it to the pallet truck or forklift using ropes. When moving the equipment, assign dedicated personnel to take care of it.
- Choose sea, roads in good conditions, or airplanes for transportation. Do not transport the equipment by railway. Avoid tilt or jolt during transportation.

Using Ladders

- Use wooden or insulated ladders when you need to perform live-line working at heights.
- Platform ladders with protective rails are preferred. Single ladders are not recommended.
- Before using a ladder, check that it is intact and confirm its load bearing capacity. Do not overload it.
- Ensure that the ladder is securely positioned and held firm.



CZ00000107

- When climbing up the ladder, keep your body stable and your center of gravity between the side rails, and do not overreach to the sides.
- When a step ladder is used, ensure that the pull ropes are secured.
- If a single ladder is used, the recommended angle for the ladder against the floor is 75 degrees, as shown in the following figure. A square can be used to measure the angle.

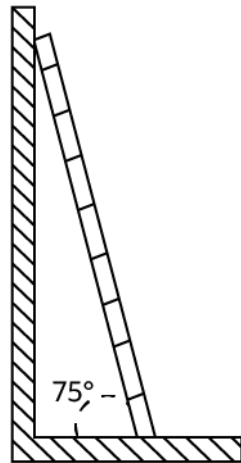

PI02SC0008

- If a single ladder is used, ensure that the wider end of the ladder is at the bottom, and take protective measures to prevent the ladder from sliding.
- If a single ladder is used, do not climb higher than the fourth rung of the ladder from the top.
- If you use a single ladder to climb up to a platform, ensure that the ladder is at least 1 m higher than the platform.

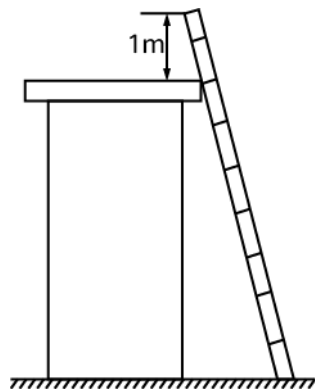

PI02SC0009

Hoisting

- Only trained and qualified personnel are allowed to perform hoisting operations.
- Install temporary warning signs or fences to isolate the hoisting area.
- Ensure that the foundation where hoisting is performed on meets the load-bearing requirements.
- Before hoisting objects, ensure that hoisting tools are firmly secured onto a fixed object or wall that meets the load-bearing requirements.
- During hoisting, do not stand or walk under the crane or the hoisted objects.
- Do not drag steel ropes and hoisting tools or bump the hoisted objects against hard objects during hoisting.
- Ensure that the angle between two hoisting ropes is no more than 90 degrees, as shown in the following figure.

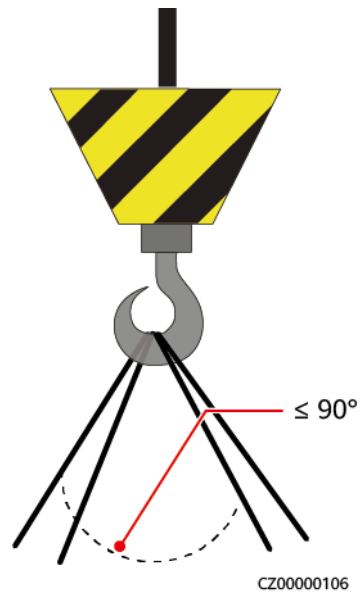

Drilling Holes

- Obtain consent from the customer and contractor before drilling holes.
- Wear protective equipment such as safety goggles and protective gloves when drilling holes.
- To avoid short circuits or other risks, do not drill holes into buried pipes or cables.
- When drilling holes, protect the equipment from shavings. After drilling, clean up any shavings.

2 Overview

2.1 Models

Model Number Description

This document involves the following product models:

- SUN2000-90KTL-H0
- SUN2000-90KTL-H1
- SUN2000-90KTL-H2
- SUN2000-95KTL-INH0
- SUN2000-95KTL-INH1
- SUN2000-100KTL-H0
- SUN2000-100KTL-H1
- SUN2000-100KTL-H2
- SUN2000-105KTL-H1

NOTE

The products look alike. The SUN2000-95KTL-INH0 is used as an example.

Figure 2-1 Model number

SUN2000-95KTL-INH0

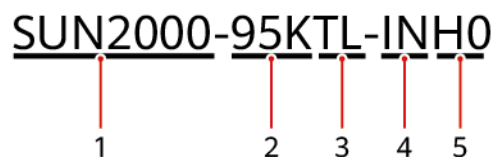

1 2 3 4 5

Table 2-1 Model number description

No.	Meaning	Description
1	Product	SUN2000: grid-tied PV inverter
2	Power	<ul style="list-style-type: none">● 90K: The power level is 90 kW.● 95K: The power level is 95 kW.● 100K: The power level is 100 kW.● 105K: The power level is 105 kW.
3	Topology	TL: transformerless
4	Region	IN: India
5	Design code	H0/H1/H2: product series with the 1500 V DC input voltage

Model Identification

You can query the SUN2000 number by the model label on the external package and the nameplate on the side of the enclosure.

Figure 2-2 Label position on the external package

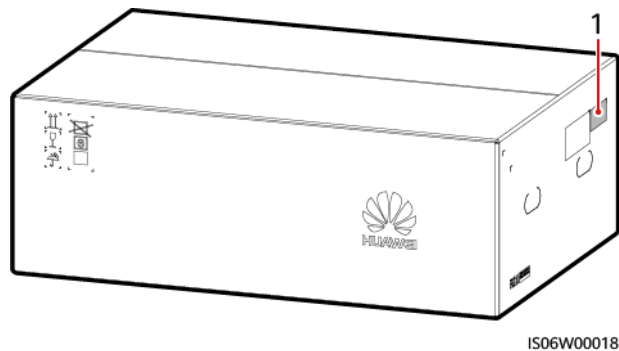

(1) Position of the model label

Figure 2-3 Nameplate

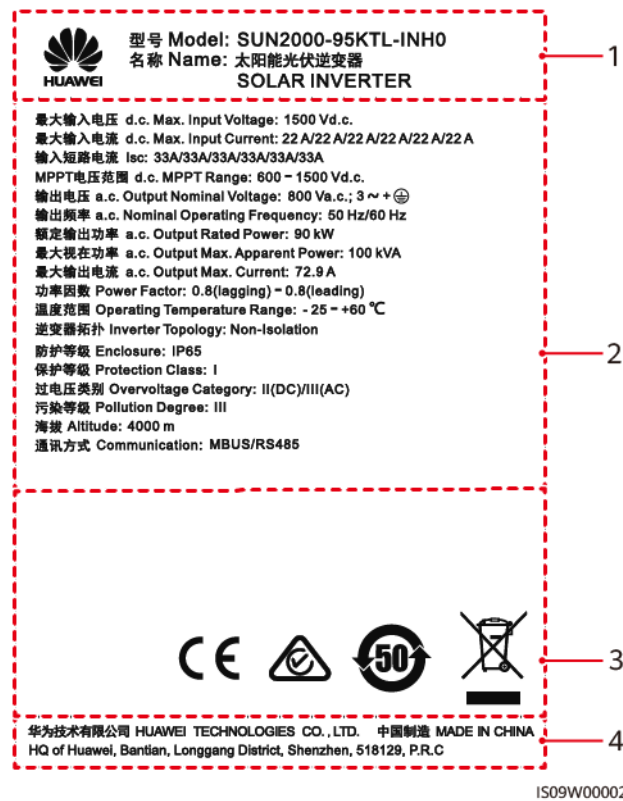

- (1) Trademark and product model
- (2) Important technical specifications
- (3) Compliance symbols
- (4) Company name and country of manufacture

NOTE

The nameplate figure is for reference only.

2.2 Product Introduction

Function

The SUN2000 is a grid-tied PV string inverter that converts the DC power generated by PV strings into AC power and feeds the power into the power grid.

Features

Intelligent

- Six independent maximum power point tracking (MPPT) circuits and 12 PV string inputs: Supports the flexible configuration of 2+2+2+2+2+2 strings.
- 12 routes of high-precision smart PV string monitoring: Help identify and rectify exceptions timely.
- MBUS networking: Uses the existing power line for communication and does not require an additional communications cable, which reduces the

construction and maintenance costs and improves communication reliability and efficiency.

- Smart I-V curve diagnosis: Implements I-V scanning and health diagnosis for PV strings. In this way, potential risks and faults can be detected in time, improving the plant operation & maintenance (O&M) quality.

Safe

- Embedded DC and AC SPDs: all-dimensional surge protection
- Embedded residual current monitoring unit: Immediately disconnects from the power grid upon detecting that the residual current exceeds the threshold.

Reliable

- Natural cooling
- Free fuse design
- Protected to IP65.
- Effective design against ground subsidence: The AC terminal block can be pulled down by up to 50 mm due to the pulling force.

Network Application

The SUN2000 applies to distributed grid-tied commercial PV systems and large-scale grid-tied PV plants. Typically, a grid-tied PV system consists of the PV string, SUN2000, AC combiner box, and step-up transformer.

Figure 2-4 Network application

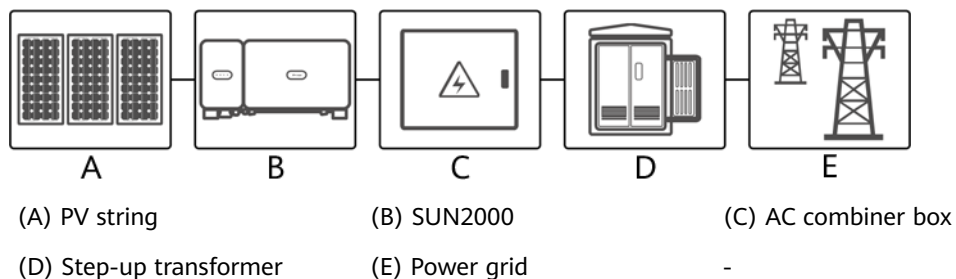

NOTE

The SUN2000 is powered by a dedicated power transformer instead of connecting to low voltage overhead power lines.

Supported Power Grid

The SUN2000 supports the IT power grid.

Figure 2-5 Supported power grid

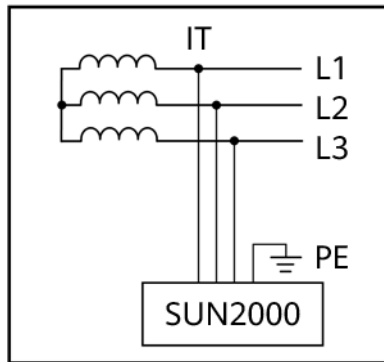

NOTE

The SUN2000 supports the IT earthing system in PV-only scenario. The use of the SUN2000 in other types of earthing systems, such as TT, TN-C, and TN-C-S, is not recommended. (If such an earthing system is encountered, contact the Company's engineers.)

2.3 Product Appearance

2.3.1 Appearance

Front View

Figure 2-6 Front view

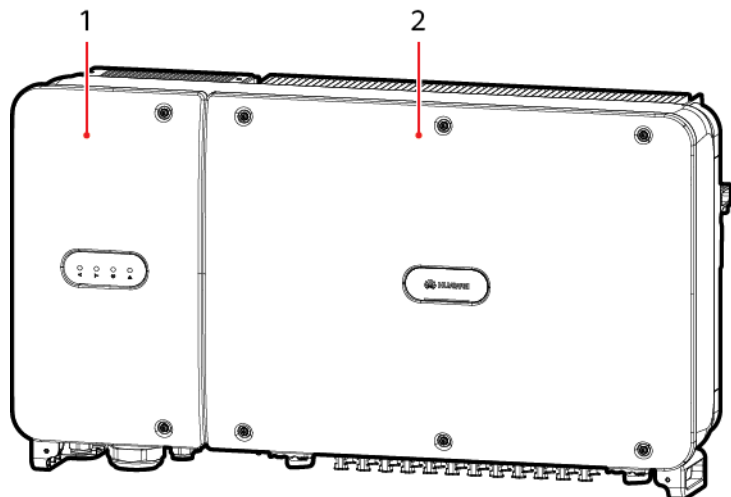

IS07W00001

(1) Maintenance compartment door

(2) Host panel

Rear View

Figure 2-7 Rear view

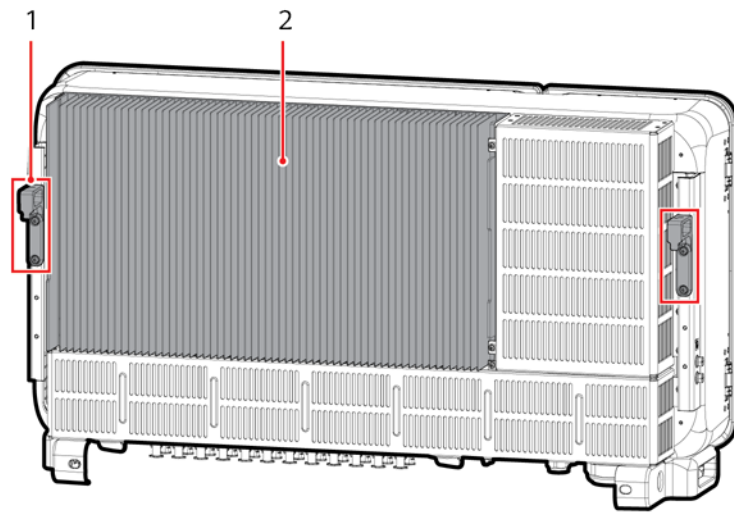

IS09W00007

(1) Mounting plate

(2) Heat sink

Bottom View

Figure 2-8 Bottom view

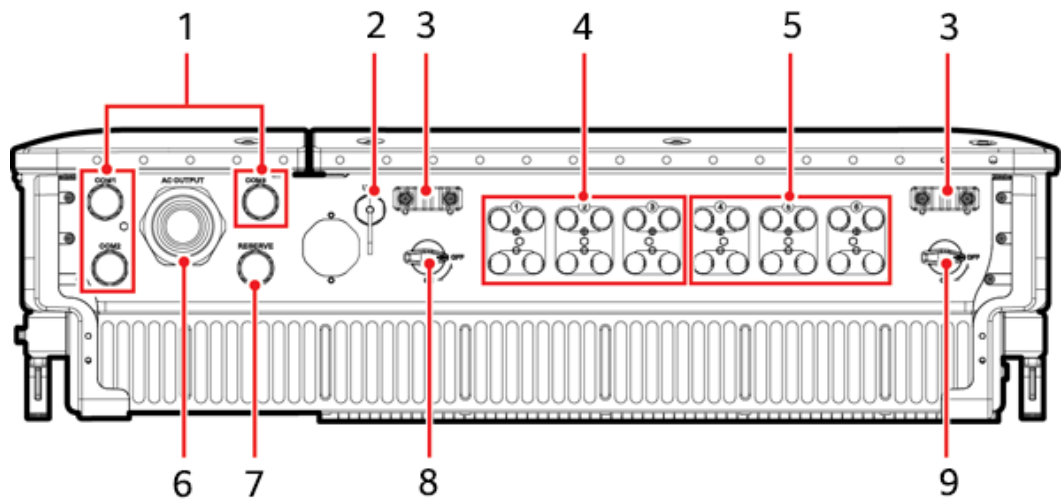

IS09W00001

No.	Component	Silk Screen	Description
1	Cable glands	COM1, COM2, COM3	Inner diameter: 14-18 mm

No.	Component	Silk Screen	Description
2	USB port	USB	Use the USB port only during maintenance (such as power-on setting, upgrade, and data export). Ensure that the USB cover is tightened when maintenance is not performed.
3	Handler	-	-
4	DC input terminals	+/-	Controlled by DC SWITCH 1
5	DC input terminals	+/-	Controlled by DC SWITCH 2
6	Cable gland	AC OUTPUT	Inner diameter: 24-57 mm
7	Cable gland	RESERVE	Inner diameter: 14-18 mm
8	DC switch 1	DC SWITCH 1	-
9	DC switch 2	DC SWITCH 2	-

Dimensions

Figure 2-9 Dimensions

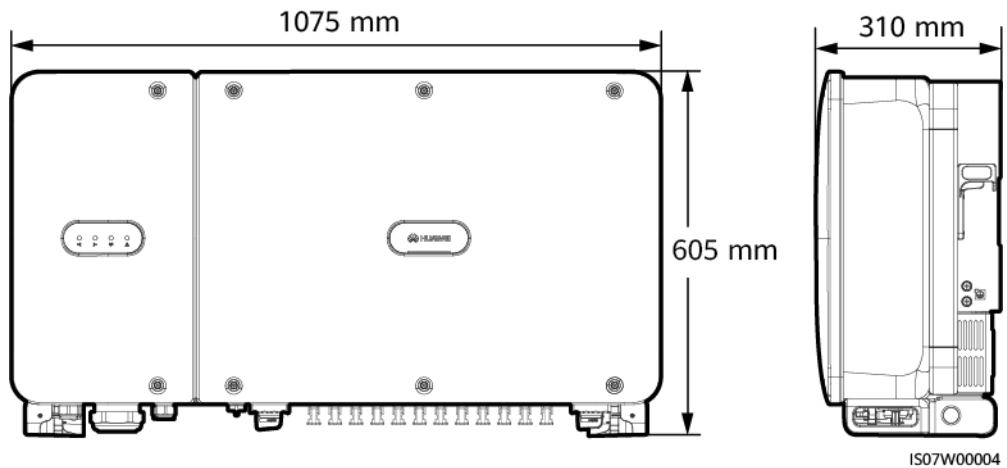

Figure 2-10 Mounting bracket dimensions

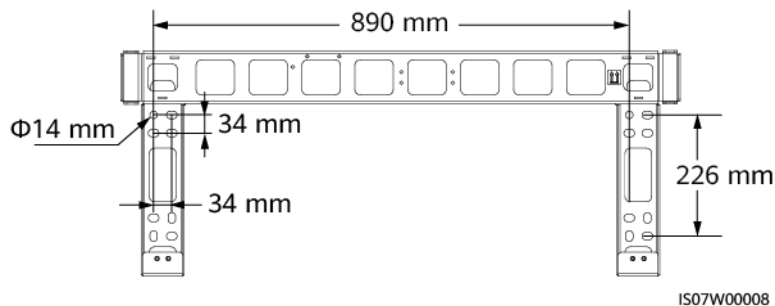
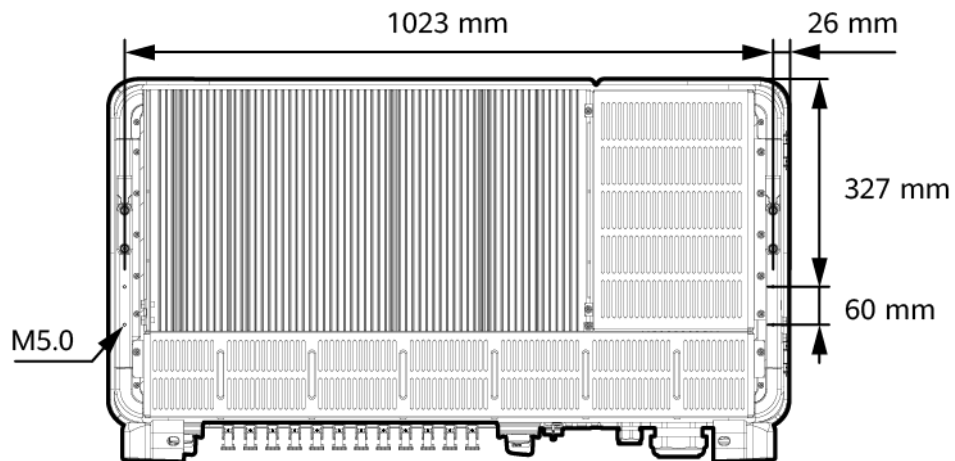

Figure 2-11 Dimensions of reserved holes on the rear



IS09W00009

NOTE

Four M5 screw holes are reserved on the rear of the SUN2000 for installing an awning.

Wiring Area

Figure 2-12 Wiring ports (SUN2000-90KTL-H0, SUN2000-90KTL-H1, SUN2000-90KTL-H2, SUN2000-95KTL-INH0, SUN2000-95KTL-INH1, SUN2000-100KTL-H1, and SUN2000-105KTL-H1)

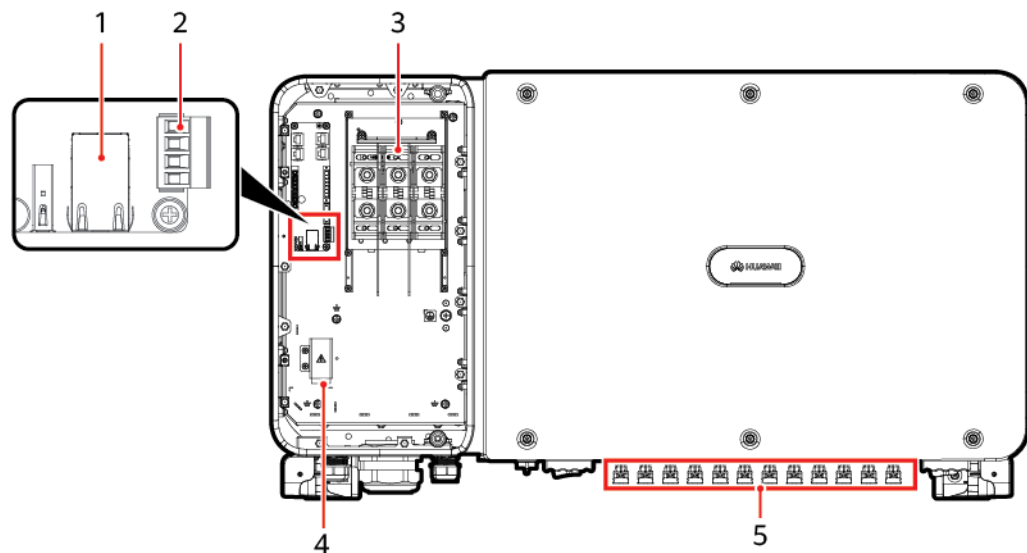

IS09W00004

- | | | |
|--|---------------------------------|-----------------------|
| (1) RS485 port (RJ45 network port) | (2) RS485 port (terminal block) | (3) AC terminal block |
| (4) Power port for the tracking system | (5) DC input terminal | - |

Figure 2-13 Wiring ports (SUN2000-100KTL-H0 and SUN2000-100KTL-H2)

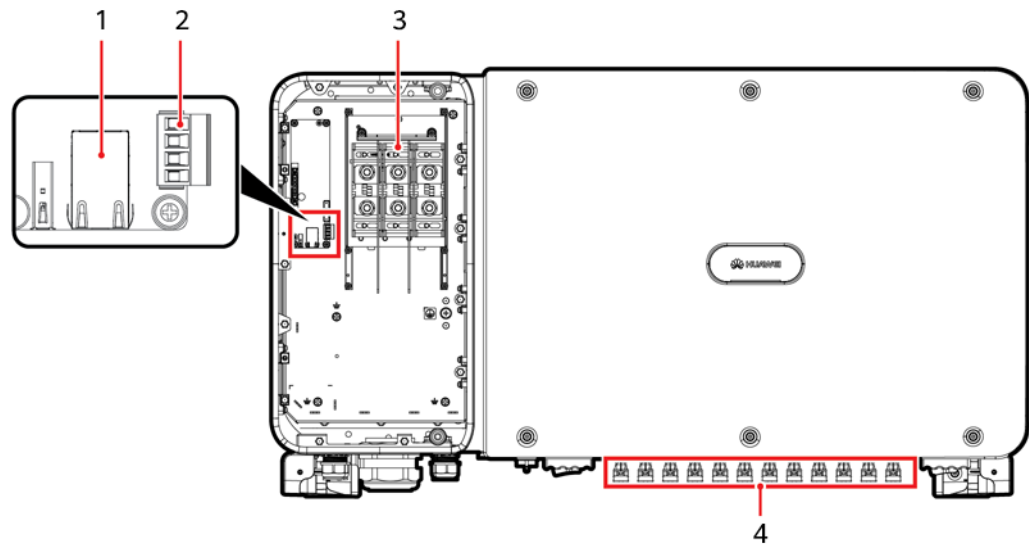

IS09W00005



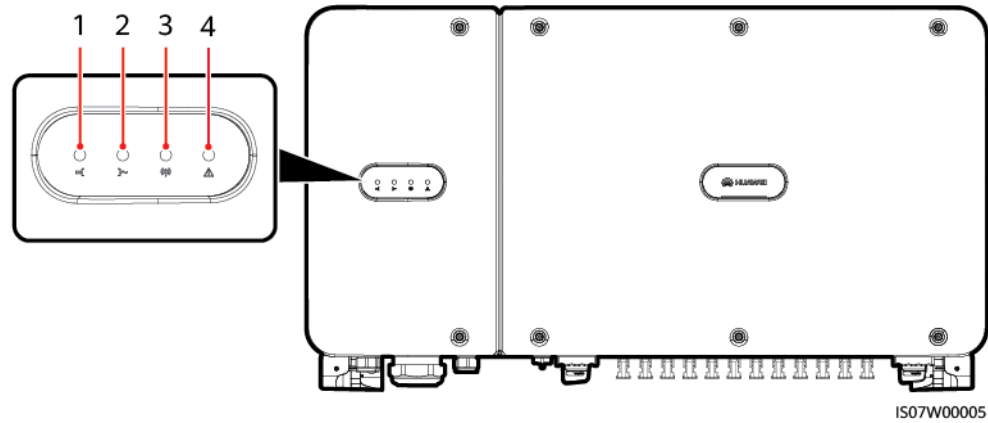

- | | | |
|------------------------------------|---------------------------------|-----------------------|
| (1) RS485 port (RJ45 network port) | (2) RS485 port (terminal block) | (3) AC terminal block |
| (4) DC input terminal | - | - |

2.3.2 Indicator Status

Figure 2-14 Indicators







IS07W00005





No.	Indicator	Status	Meaning	
1	PV connection indicator 	Steady green	At least one PV string is properly connected, and the DC input voltage of the corresponding MPPT circuit is higher than or equal to 600 V.	
		Off	The SUN2000 disconnects from all PV strings, or the DC input voltage of each MPPT circuit is less than 600 V.	
2	Grid-tied indicator 	Steady green	The SUN2000 is in grid-tied mode.	
		Off	The SUN2000 is not in grid-tied mode.	
3	Communication indicator 	Blinking green	The SUN2000 receives communications data normally.	
		Off	The SUN2000 receives no communications data for 10s.	
4	Alarm/Maintenance indicator 	Alarm state	Blinking red at long intervals (on for 1s and then off for 4s)	A warning alarm is generated.
			Blinking red at short intervals (on for 0.5s and then off for 0.5s)	A minor alarm is generated.
			Steady red	A major alarm is generated.
		Local maintenance state	Blinking green at long intervals (on for 1s and then off for 1s)	Local maintenance is in progress.
			Blinking green at short intervals (on for 0.125s and then off for 0.125s)	Local maintenance fails.
			Steady green	Local maintenance succeeds.

 NOTE

- Local maintenance refers to operations performed after a USB flash drive, a WLAN module, a Bluetooth module, or a USB data cable is inserted into the USB port of the solar inverter. For example, local maintenance includes data import and export using a USB flash drive, and connecting to the SUN2000 app over a WLAN module, a Bluetooth module, or a USB data cable.
- If the alarming and the local maintenance happen concurrently, the alarm/maintenance indicator shows the local maintenance state first. After the USB flash drive, WLAN module, Bluetooth module, or USB data cable is removed, the indicator shows the alarm state.

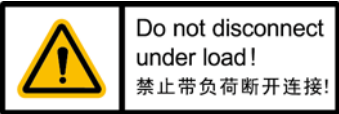
2.3.3 Label Description

Label	Name	Meaning
	Running warning	Potential hazards exist after the SUN2000 is powered on. Take protective measures when operating the SUN2000.
	Burn warning	Do not touch a running SUN2000, as the shell becomes hot during operation.
	Delayed discharge	<ul style="list-style-type: none"> • High voltage exists after the SUN2000 is powered on. Only qualified and trained electrical technicians are allowed to perform operations on the SUN2000. • Residual voltage exists after the SUN2000 is powered off. It takes 15 minutes for the SUN2000 to discharge to the safe voltage.
	Refer to documentation	Reminds operators to refer to the documents shipped with the SUN2000.
	Grounding	Indicates the position for connecting the protective earthing (PE) cable.

Label	Name	Meaning
	Operation warning	Do not remove the DC input connector when the SUN2000 is running.
	High voltage warning	High voltage exists after the SUN2000 is powered on. Read this document carefully before operating the SUN2000.
	DC terminal operation warning	<p>High voltage exists after the SUN2000 is powered on. To avoid electric shocks, perform the following system power-off operations before plugging or unplugging DC input connectors of the SUN2000:</p> <ol style="list-style-type: none"> 1. Send a shutdown command. 2. Turn off the downstream AC switch. 3. Turn off all DC switches at the bottom.
	SUN2000 SN label	Indicates the SUN2000 serial number.
	Weight label	The SUN2000 needs to be carried by four persons or using a pallet truck.

2.4 Working Principles

2.4.1 Circuit Diagram

The SUN2000 receives inputs from 12 PV strings. The inputs are grouped into 6 MPPT circuits inside the SUN2000 to track the maximum power point of the PV strings. The DC power is then converted into three-phase AC power through an inverter circuit. Surge protection is supported on both the DC and AC sides.

Figure 2-15 Conceptual diagram

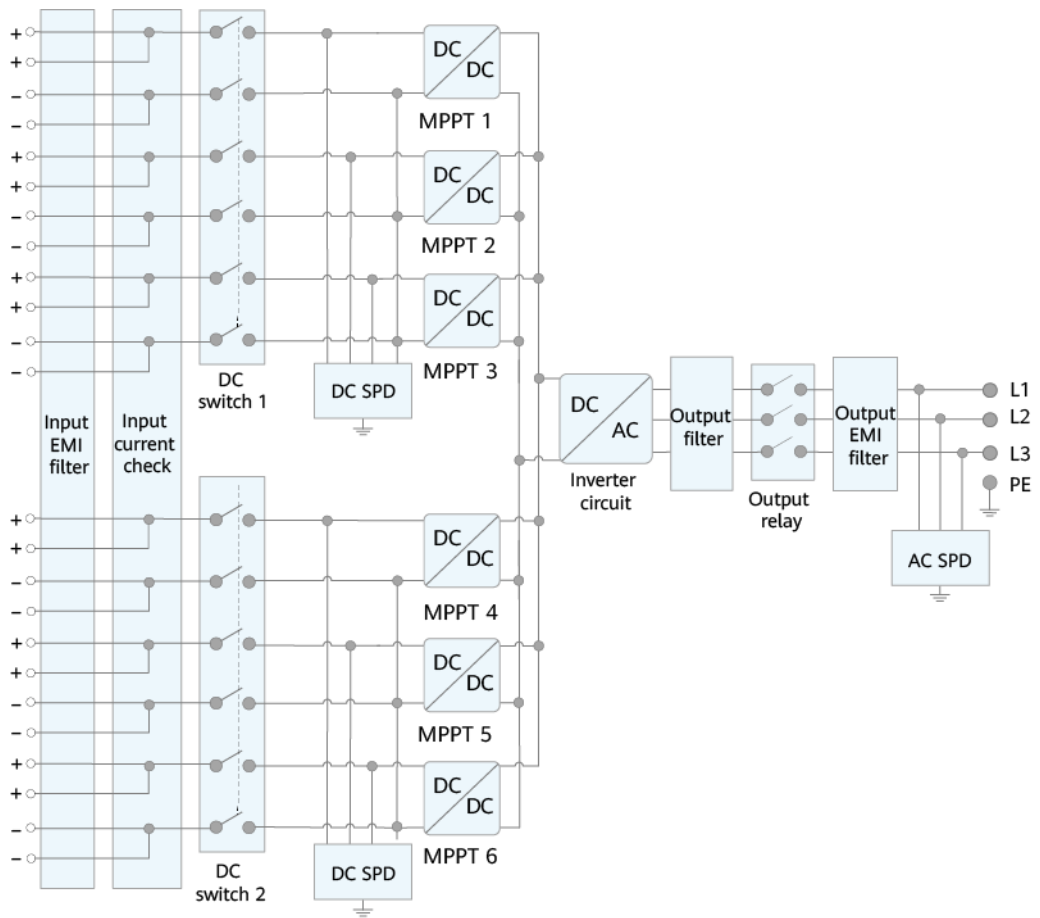

IS09W00008

2.4.2 Working Modes

The SUN2000 can work in Standby, Operating, or Shutdown mode.

Figure 2-16 Working modes

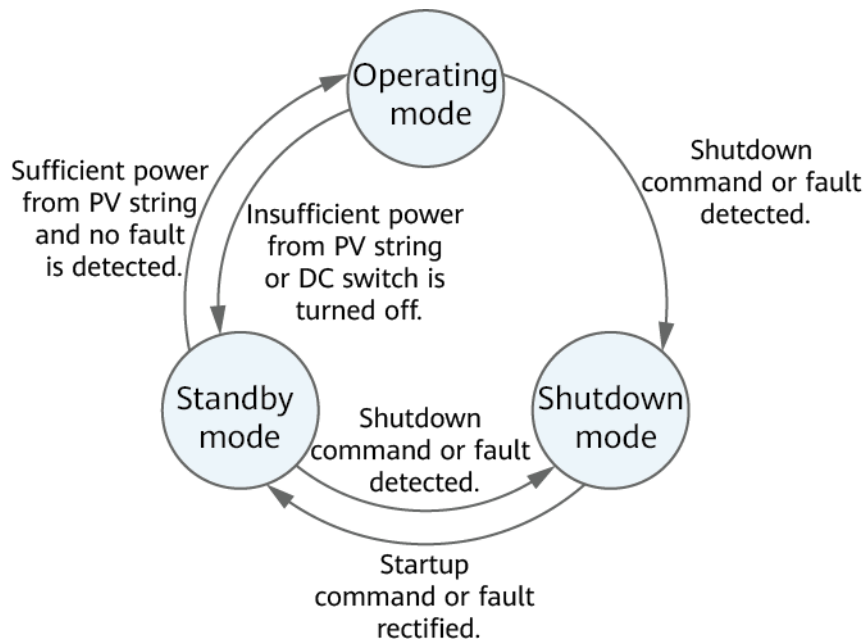

IS07500001

Table 2-2 Working mode description

Working Mode	Description
Standby	<p>The SUN2000 enters Standby mode when the external environment does not meet the operating requirements. In Standby mode:</p> <ul style="list-style-type: none"> The SUN2000 continuously performs status check and enters the Operating mode once the operating requirements are met. The SUN2000 enters Shutdown mode after detecting a shutdown command or a fault after startup.
Operating	<p>In Operating mode:</p> <ul style="list-style-type: none"> The SUN2000 converts DC power from PV strings into AC power and feeds the power to the power grid. The SUN2000 tracks the maximum power point to maximize the PV string output. If the SUN2000 detects a fault or a shutdown command, it enters the Shutdown mode. The SUN2000 enters Standby mode after detecting that the PV string output power is not suitable for connecting to the power grid for generating power.
Shutdown	<ul style="list-style-type: none"> In Standby or Operating mode, the SUN2000 enters Shutdown mode after detecting a fault or shutdown command. In Shutdown mode, the SUN2000 enters Standby mode after detecting a startup command or that the fault is rectified.

2.5 Smart I-V Curve Diagnosis

The inverter supports the Smart I-V Curve Diagnosis function. For details, see the [iMaster NetEco V600R023C00 Smart I-V Curve Diagnosis User Manual](#).

3 Storage

The following requirements should be met if the SUN2000 is not put into use directly:

- Do not remove the packing materials, and check the packing materials regularly (recommended: every three months). If any rodent bites are found, replace the packing materials immediately. If the solar inverter is unpacked but not put into use immediately, put it inside the original package with the desiccant bag, and seal it using tape.
- The ambient temperature and humidity should be suitable for the storage. The air must not contain corrosive or flammable gases.

Figure 3-1 Storage temperature and humidity

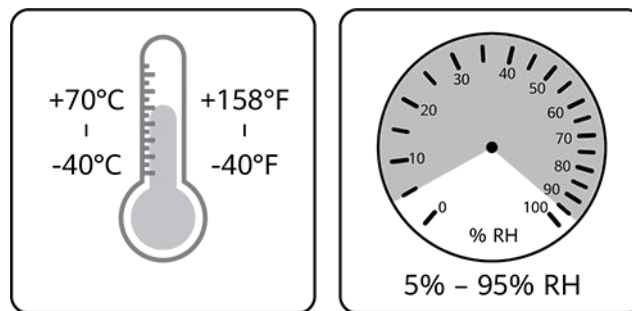

IS07W00011

- The solar inverter should be stored in a clean and dry place and be protected from dust and water vapor corrosion. The solar inverter must be protected against rain and water.
- Do not tilt the package or place it upside down.
- To avoid personal injury or device damage, stack inverters with caution to prevent them from falling over.

Figure 3-2 Maximum number of pile-up layers allowed

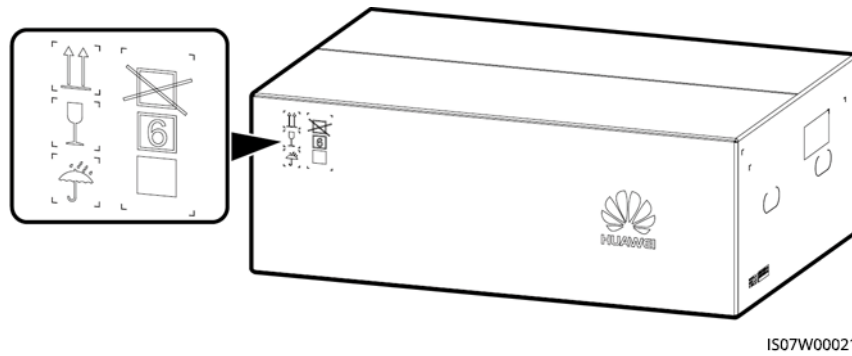

- If an inverter has been stored for two years or longer, it must be checked and tested by professionals before being put into use.

4 Installation

4.1 Checking Before Installation

Outer Packing Materials

Before unpacking the inverter, check the outer packing materials for damage, such as holes and cracks, and check the inverter model. If any damage is found or the inverter model is not what you requested, do not unpack the package and contact your supplier as soon as possible.

 **NOTE**

You are advised to remove the packing materials within 24 hours before installing the inverter.

Package Contents

NOTICE









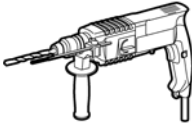
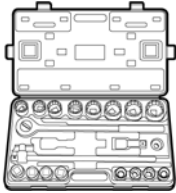

- After placing the equipment in the installation position, unpack it with care to prevent scratches. Keep the equipment stable during unpacking.

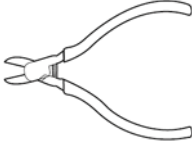
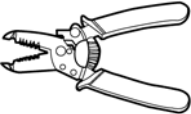



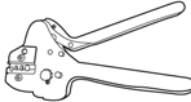
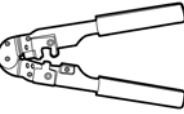





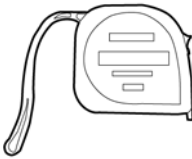

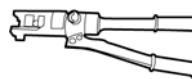
After unpacking the inverter, check that the contents are intact and complete. If any damage is found or any component is missing, contact your supplier.

 **NOTE**

For details about the number of contents, see the *Packing List* in the packing case.

4.2 Tool Preparation

Category	Tool			
Installation	 Hammer drill (with $\Phi 14$ mm and $\Phi 16$ mm drill bits)	 Socket wrench set	 Insulated torque socket wrench	 Phillips insulated torque screwdriver (M4)
	 Diagonal pliers	 Wire stripper	 Rubber mallet	 Flat-head insulated torque screwdriver (M4 bit: 0.6 mm x 3.5 mm)
	 Utility knife	 Cable cutter	 Crimping tool (model: UTXTC0003; manufacturer: Amphenol)	 RJ45 crimping tool
	 Removal wrench (model: UXTWA001; manufacturer: Amphenol)	 Vacuum cleaner	 Multimeter (DC voltage measurement range ≥ 1500 V DC)	 Marker

Category	Tool			
	 Measuring tape	 Bubble or digital level	 Hydraulic pliers	 Heat shrink tubing
	 Heat gun	 Cable tie	 Crimping tool Model: 32.6020-22100-HZ; manufacturer: Staubli	 Removal wrench Model: 13001462; manufacturer: Staubli
PPE	 Insulated gloves	 Safety goggles	 Dust mask	 Insulated shoes
	 Protective gloves	-	-	-

4.3 Determining the Installation Position

Installation Environment Requirements

- Do not install the inverter in working or living areas.
- Do not install the inverter in noise-sensitive areas (such as residential areas, office areas, and schools) to avoid complaints. If the preceding areas are unavoidable, the distance between the installation position and noise-sensitive areas must be greater than 40 m. Alternatively, use other low-noise models.

- If the device is installed in public places (such as parking lots, stations, and factories) other than working and living areas, install a protective net outside the device, set up a safety warning sign to isolate the device, and prevent unauthorized personnel from approaching the inverter. This is to avoid personal injury or property loss caused by accidental contact or other reasons during device operation.
- If the equipment is installed in a place with abundant vegetation, in addition to routine weeding, harden the ground underneath the equipment using cement or gravel (the area shall be greater than or equal to 3 m x 2.5 m).
- Do not install the inverter in areas with flammable materials.
- Do not install the inverter in areas with explosive materials.
- Do not install the inverter in areas with corrosive materials.
- Do not install the inverter where its enclosure and heat sinks are easily accessible, because the voltage is high and these parts are hot during operation.
- Install the inverter in a well-ventilated environment for heat dissipation.
- Install the inverter in an environment with a magnetic field strength less than 4 Gauss. If the magnetic field strength is high, for example, in a smeltery, you are advised to use a gauss meter to measure the magnetic field strength of the inverter installation position when the smelting equipment is running normally. If the magnetic field strength is greater than or equal to 4 Gauss, the inverter may fail to work properly.
- If the inverter is installed in an airtight environment, a heat dissipation device or ventilation device must be installed to ensure that the indoor ambient temperature is not higher than the external ambient temperature during operation.
- You are advised to install the inverter in a sheltered place or install an awning over it.
- The inverter will be corroded in salt areas. Before installing the inverter outdoors in salt areas, consult Huawei. A salt area refers to the region within 500 meters from the coast or prone to sea breeze. The regions prone to sea breeze vary with weather conditions (such as typhoons and monsoons) or terrains (such as dams and hills).

Mounting Structure Requirements

- The mounting structure where the SUN2000 is installed must be fire resistant. Do not install the SUN2000 on flammable building materials.
- Ensure that the installation surface is solid enough to bear the weight load.
- In residential areas, do not install the SUN2000 on drywalls or walls made of similar materials with a weak sound insulation performance because the noise generated by the SUN2000 is noticeable.

Figure 4-1 Mounting structure

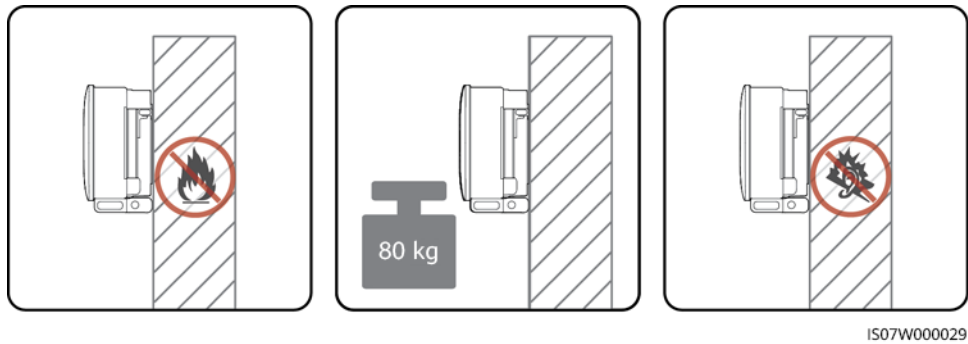

Installation Angle Requirements

The SUN2000 can be support-mounted or wall-mounted. The installation angle requirements are as follows:

- Install the SUN2000 vertically or at a maximum back tilt of 15 degrees to facilitate heat dissipation.
- Do not install the SUN2000 at forward tilted, excessive back tilted, side tilted, horizontal, or upside down positions.

Figure 4-2 Installation tilts

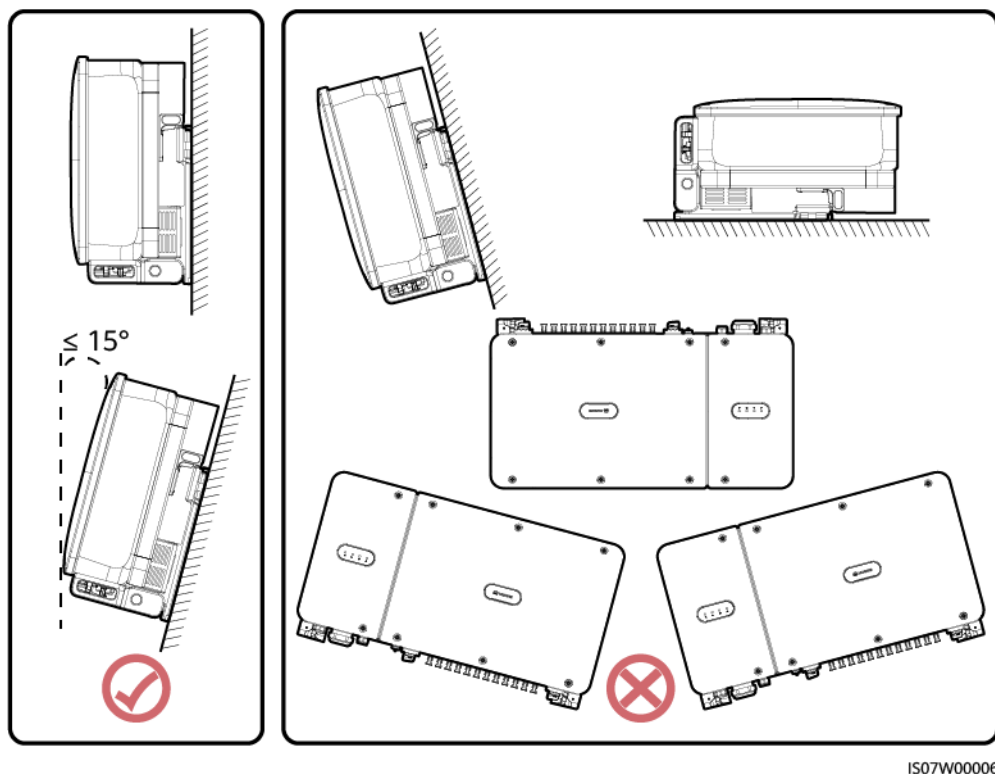

Installation Space Requirements

Reserve enough space around the SUN2000 for installation and heat dissipation.

Figure 4-3 Installation space

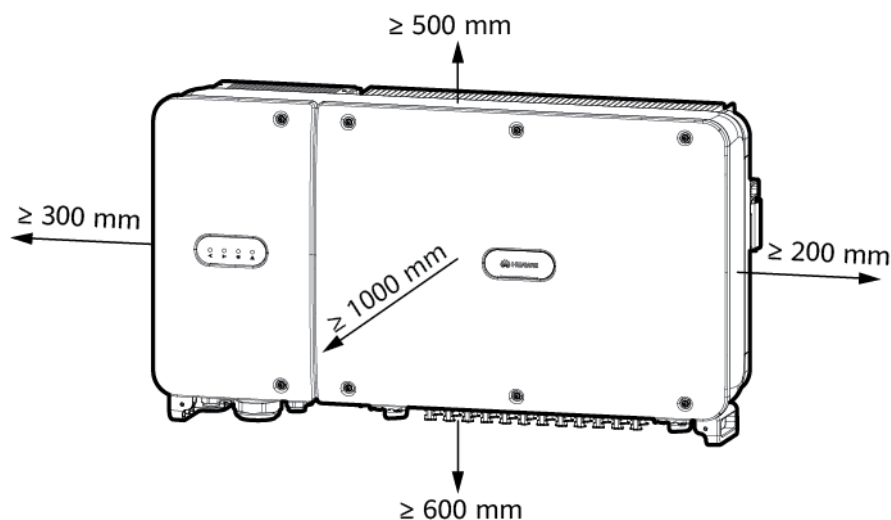

IS07W00007

NOTE

For ease of installing the SUN2000 on the mounting bracket, connecting cables to the bottom of the SUN2000, and maintaining the SUN2000 in future, it is recommended that the bottom space be from 600 mm to 730 mm. If you have any question about the distance, consult the local technical support engineers.

When installing multiple SUN2000s, install them in horizontal mode if sufficient space is available and install them in staggered mode if no sufficient space is available. Stacked installation is not recommended.

Figure 4-4 Horizontal installation mode (recommended)

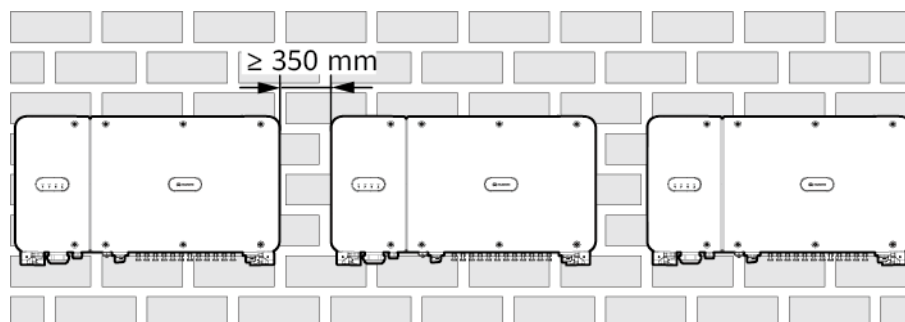

IS07H00001

Figure 4-5 Staggered installation mode (recommended)

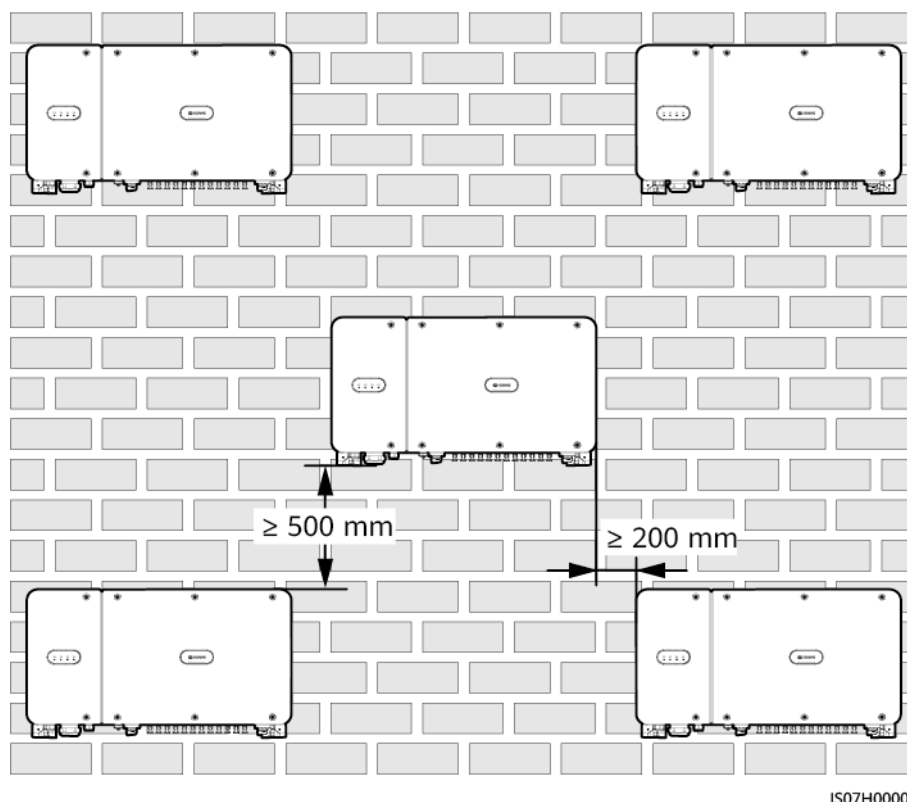
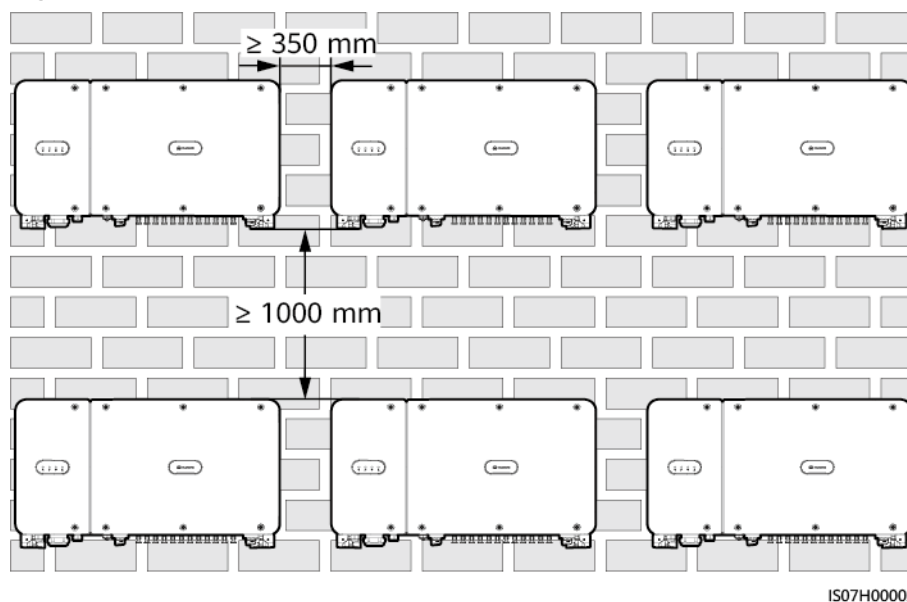

Figure 4-6 Stacked installation mode (not recommended)



4.4 Installing the Mounting Bracket

Before installing the mounting bracket, remove the security Torx wrench and save it for later use.

Figure 4-7 Position for binding the security Torx wrench

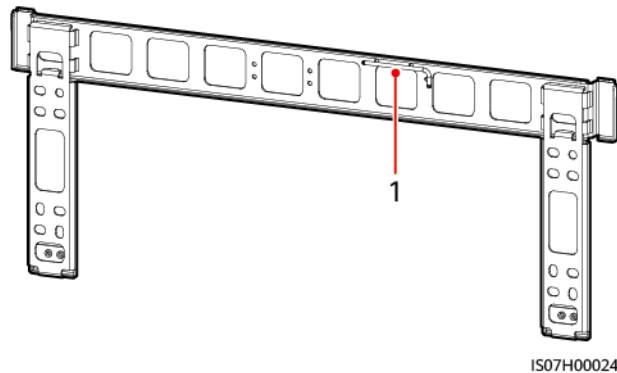

(1) Position for binding the security Torx wrench

The SUN2000 mounting bracket has four groups of screw holes, each group containing four holes. Mark any one hole in each group based on site requirements and mark four holes in total. The two round holes are recommended.

Figure 4-8 Hole dimensions

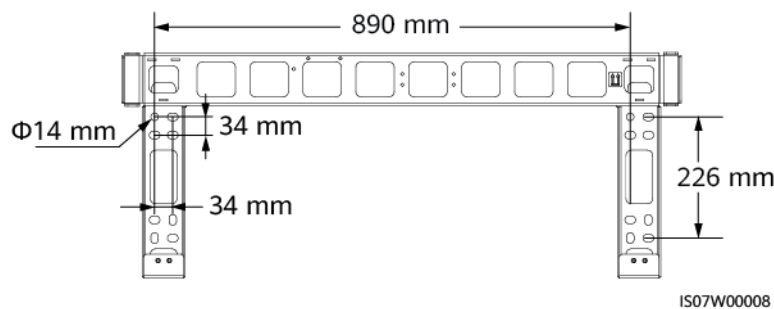

4.4.1 Support-Mounted Installation

Prerequisites

The M12x40 bolt assemblies are delivered with the mounting bracket. If the bolt assembly length does not meet the installation requirements, prepare M12 bolt assemblies by yourself and use them together with the delivered M12 nuts.

Procedure

- Step 1** Determine the positions for drilling holes using the mounting bracket. Level the positions of mounting holes using a bubble or digital level, and mark the positions with a marker.
- Step 2** Drill holes using a hammer drill. You are advised to apply anti-rust paint on the hole positions for protection.
- Step 3** Secure the mounting bracket.

Figure 4-9 Installing the mounting bracket

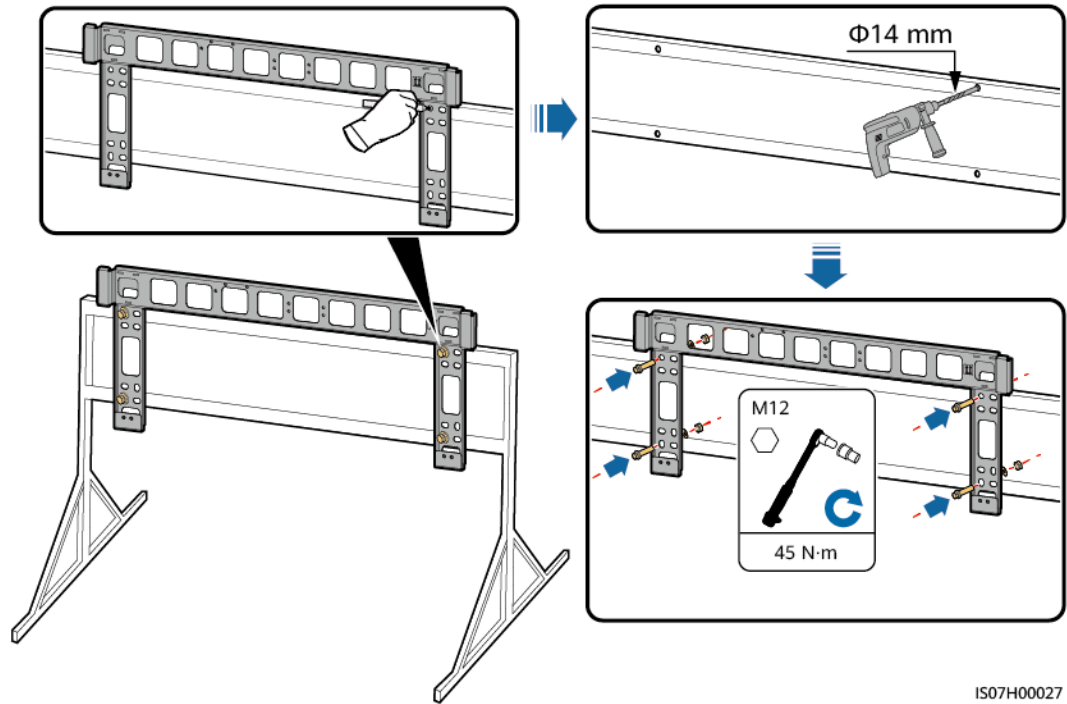

IS07H00027

----End

4.4.2 Wall-Mounted Installation

Prerequisites

You have prepared the expansion bolts. M12x60 stainless expansion bolts are recommended.

Procedure

- Step 1** Determine the positions for drilling holes using the mounting bracket. Level the positions of mounting holes using a bubble or digital level, and mark the positions with a marker.
- Step 2** Drill holes using a hammer drill and install expansion bolts.

WARNING

Avoid drilling holes in the water pipes and power cables buried in the wall.

NOTICE

- To prevent dust inhalation or contact with eyes, wear an anti-dust respirator and safety goggles when drilling holes.
- Clean up any dust in and around the holes using a vacuum cleaner and measure the distance between holes. If the holes are inaccurately positioned, drill a new set of holes.
- Level the head of the expansion sleeve with the concrete wall after removing the bolt, spring washer, and flat washer. Otherwise, the mounting bracket will not be securely installed on the concrete wall.

Step 3 Secure the mounting bracket.

Figure 4-10 Installing the mounting bracket

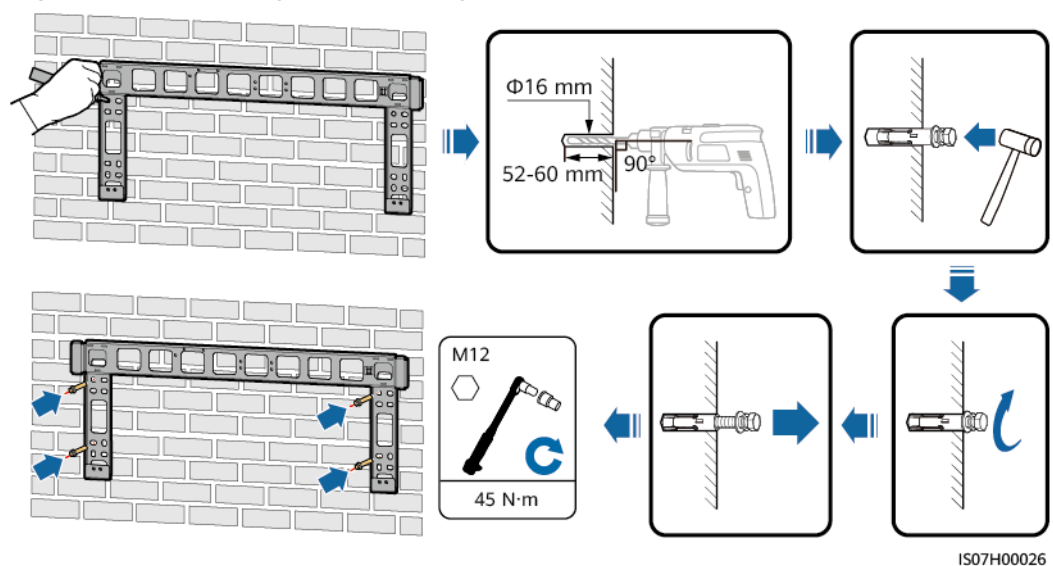

----End

4.5 Installing the SUN2000

Context

NOTICE

- Handle the SUN2000 with care when moving it to prevent device damage and personal injury.
- It takes multiple persons or a pallet truck to move the SUN2000.
- Do not place the SUN2000 with its wiring terminals at the bottom contacting the floor or any other objects because the terminals are not designed to bear the weight of the SUN2000.
- When you need to temporarily place the SUN2000 on the ground, use foam, paper, or other protection material to prevent damage to its cover.

Procedure

Step 1 Lift the SUN2000 from the packing case and move it to the installation position.

Figure 4-11 Taking out the SUN2000

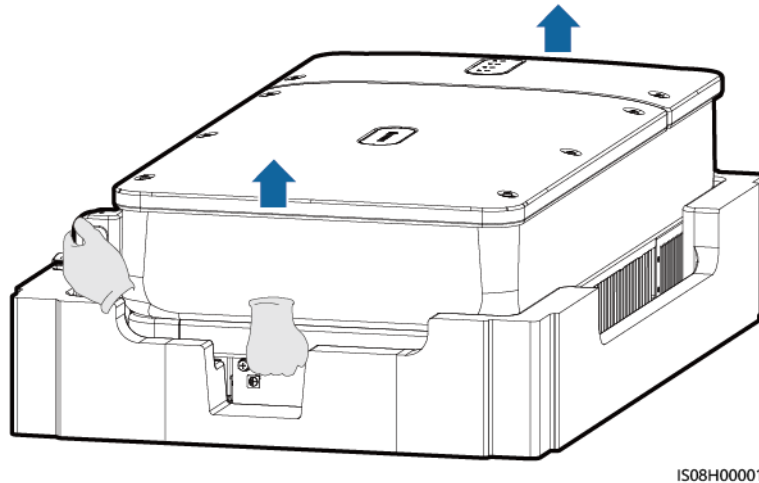

IS08H00001

Step 2 For the SUN2000-90KTL-H2 used in Australia, install the delivered screw for locking each DC switch.

Figure 4-12 Installing screws

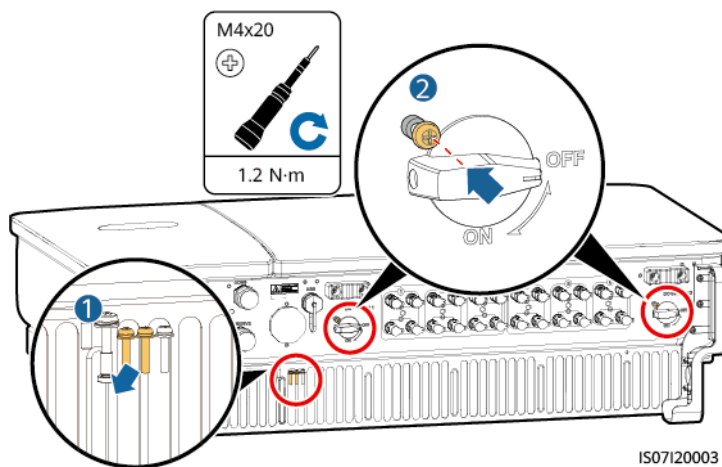

IS07I20003

Step 3 Lift the SUN2000 and keep it upright.

Figure 4-13 Lifting the SUN2000 and keeping it upright

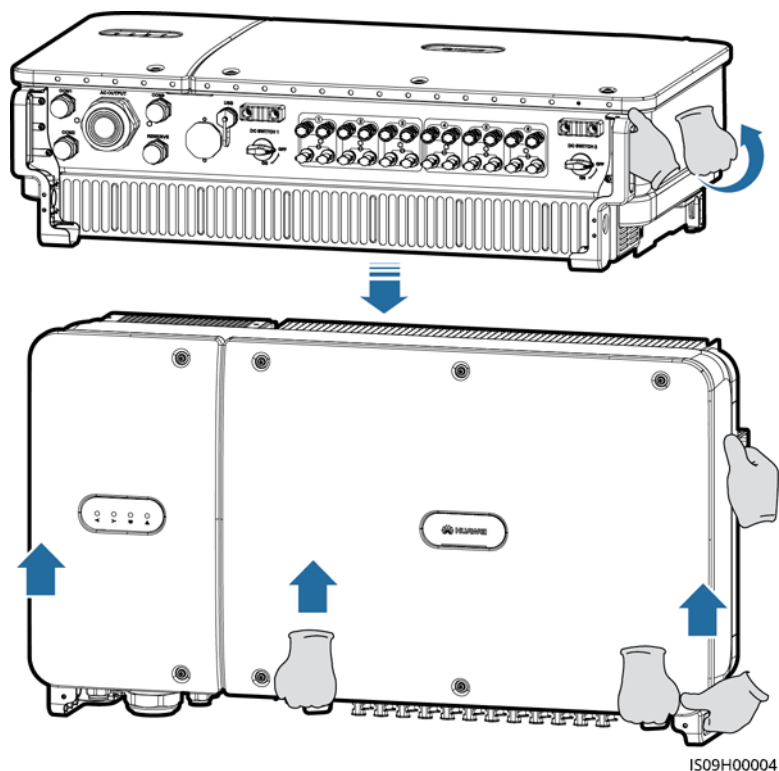

Step 4 If the installation position is too high to install the SUN2000 on the mounting bracket, run a rope that is strong enough to bear the SUN2000 through the two lifting eyes, and hoist the SUN2000.

NOTICE

Hoist the SUN2000 with care to protect it from colliding with the wall or other objects.

Figure 4-14 Hoisting the SUN2000

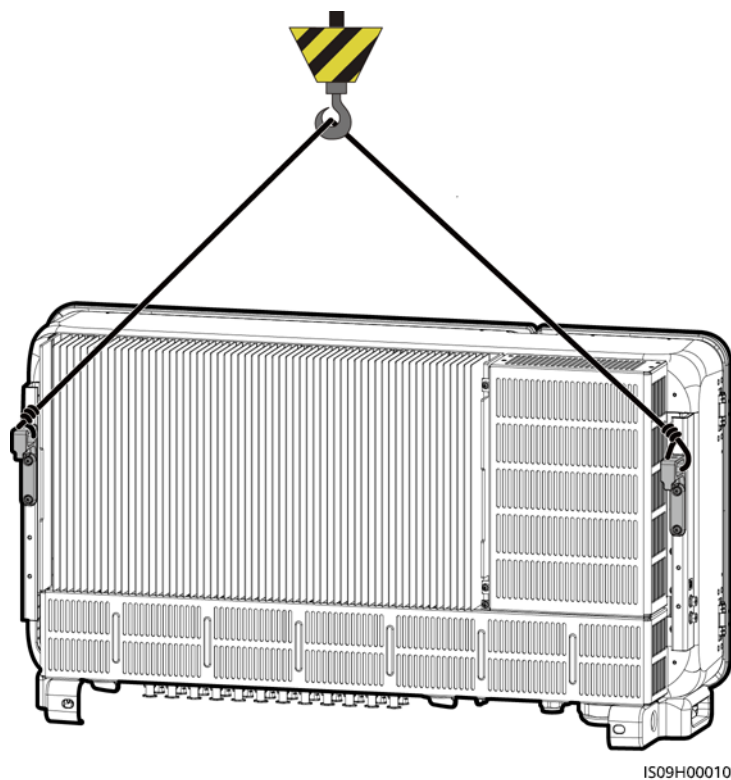

Step 5 Install the SUN2000 on the mounting bracket and align the SUN2000 enclosure with the mounting bracket.

Figure 4-15 Mounting the SUN2000

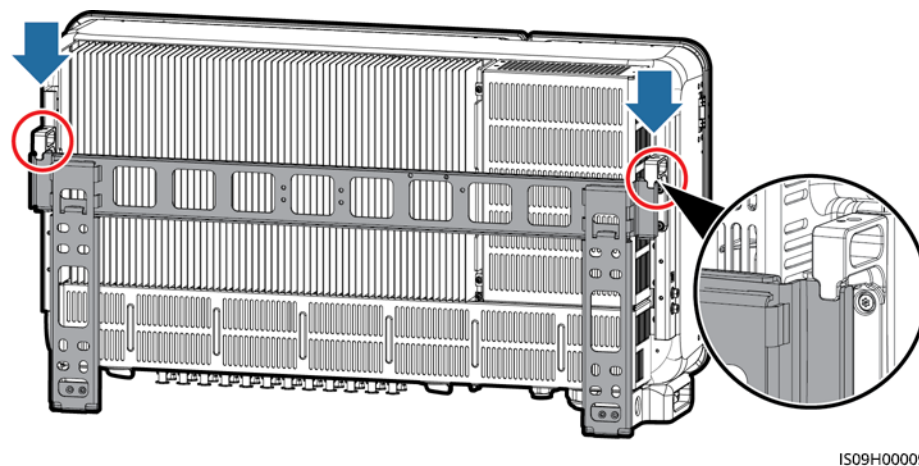

Step 6 Secure the SUN2000.

Figure 4-16 Tightening security Torx screws

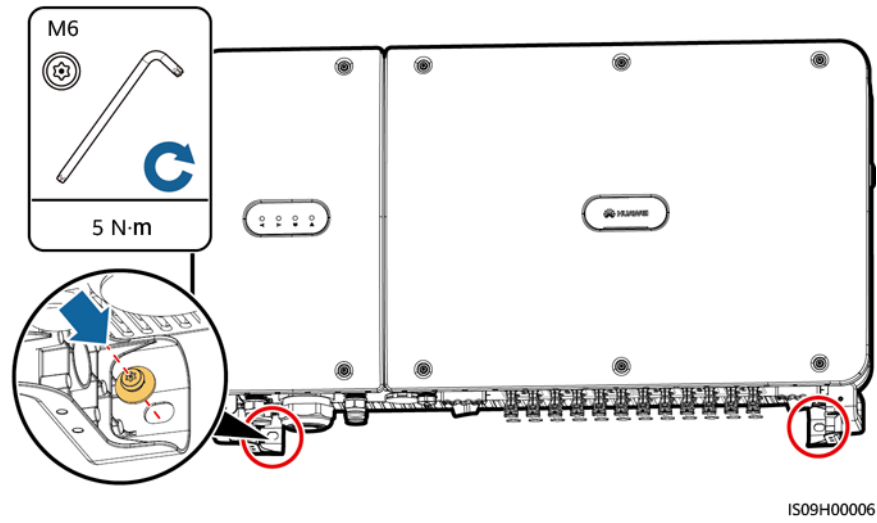

----End

5 Electrical Connections

5.1 Precautions

 **DANGER**

When exposed to sunlight, the PV arrays supply DC voltage to the inverter. Before connecting cables, ensure that all **DC SWITCH** on the inverter are OFF. Otherwise, the high voltage of the inverter may result in electric shocks.

 **DANGER**

- The site must be equipped with qualified fire fighting facilities, such as fire sand and carbon dioxide fire extinguishers.
 - Wear personal protective equipment and use dedicated insulated tools to avoid electric shocks or short circuits.
-

 **WARNING**

- The equipment damage caused by incorrect cable connections is beyond the warranty scope.
 - Only certified electrician can perform electrical terminations.
 - Operation personnel must wear PPE when connecting cables.
 - Before connecting cables to ports, leave enough slack to reduce the tension on the cables and prevent poor cable connections.
-

CAUTION

- Stay away from the equipment when preparing cables to prevent cable scraps from entering the equipment. Cable scraps may cause sparks and result in personal injury and equipment damage.
- When routing PV cables whose pipe is less than 1.5 m long, the positive and negative PV string cables shall be routed in different pipes to prevent cable damage and short circuits caused by improper operations during construction.

NOTE

The cable colors shown in the electrical connection diagrams provided in this section are for reference only. Select cables in accordance with local cable specifications (green-and-yellow cables are only used for protective earthing).

5.2 Preparing Cables

The SUN2000 supports MBUS and RS485 communication modes.

5.2.1 MBUS Communication

If MBUS is selected, no RS485 communications cable is required to connect to the SUN2000, but the AC power cable needs to connect to a SmartLogger that supports MBUS.

NOTICE

The MBUS communication mode is only applicable to medium-voltage grid connection scenarios and non-low-voltage public grid connection scenarios (industrial environment).

Figure 5-1 Network Application

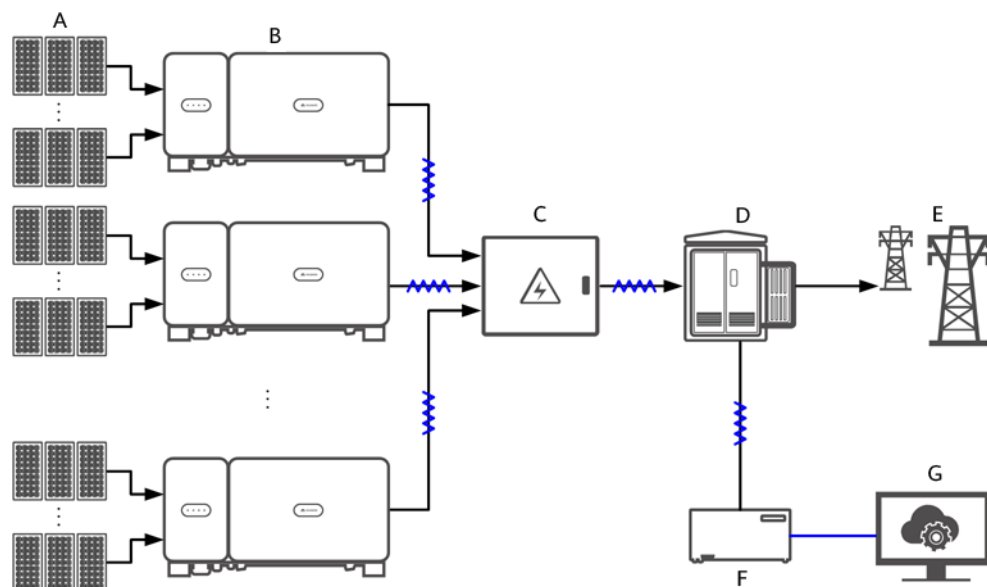

NOTE

— indicates a power cable; → indicates the power flow direction; — indicates a signal cable;  indicates the signal flow.

- (A) PV string
- (B) SUN2000
- (C) AC combiner box
- (D) Step-up transformer
- (E) Power grid
- (F) SmartLogger
- (G) Management system

Figure 5-2 SUN2000 cable connections (dashed box indicating optional components)

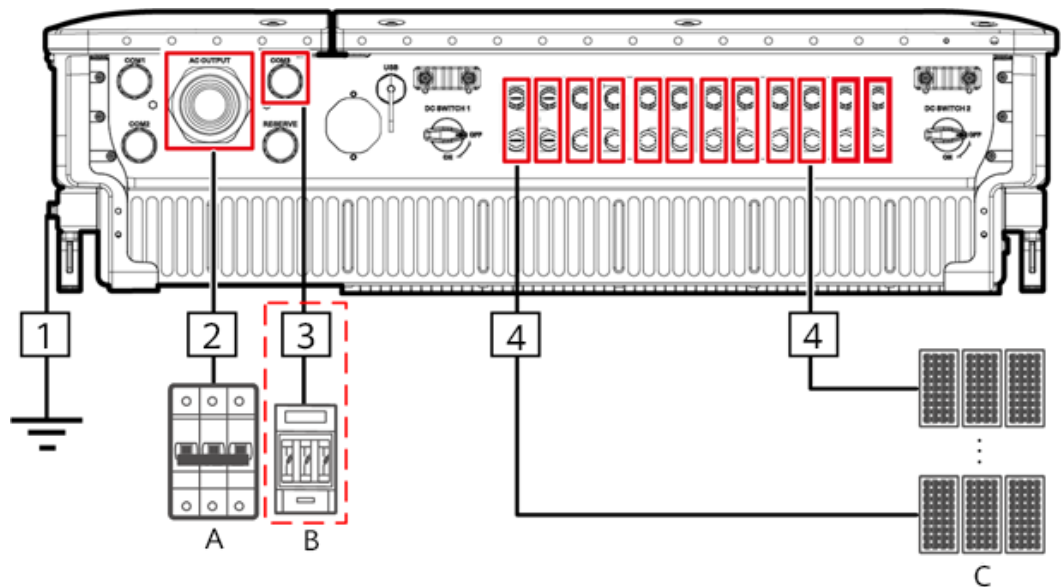

Table 5-1 Component description

No.	Component	Remarks	Source
A	AC switch	<ul style="list-style-type: none"> • Installed in the AC combiner box • It is recommended that a three-phase AC circuit breaker with a rated voltage greater than or equal to 800 V AC and a rated current of 125 A be configured for the SUN2000-105KTL-H1. • It is recommended that a three-phase AC circuit breaker with a rated voltage greater than or equal to 800 V AC and a rated current of 100 A be configured for other models. 	Prepared by the customer

No.	Component	Remarks	Source
B	Fuse/Circuit breaker	<p>The tracking system should be equipped with an overcurrent protective device/component. The power cable between the device/component and wiring terminal should be no longer than 2.5 m.</p> <p>Therefore, a fuse or circuit breaker is recommended.</p> <ul style="list-style-type: none"> Installed between the SUN2000 and tracking control box Fuse specifications: rated voltage \geq 800 V; rated current: 6 A; protection: gG Circuit breaker specifications: rated voltage \geq 800 V; rated current: 6 A; tripping: C 	Prepared by the customer
C	PV string	<ul style="list-style-type: none"> A PV string is composed of PV modules connected in series. The SUN2000 supports the input from 12 PV strings. 	Prepared by the customer

NOTICE

The SUN2000 has an RCMU inside. Its external AC switch should be a three-phase circuit breaker or other AC load circuit breakers to safely disconnect the SUN2000 from the power grid.

Table 5-2 Cable description

No.	Cable	Type	Conductor Cross-Sectional Area Range	Outer Diameter	Source
1	PE cable	<p>Single-core outdoor copper cable and M8 OT/DT terminal</p> <p>NOTICE Preferred to connect to the PE point on the enclosure. The PE point in the maintenance compartment is used for connecting to the PE cable included in the multi-core AC power cable.</p>	$\geq 16 \text{ mm}^2$. For details, see Table 5-3 .	-	Prepared by the customer

No.	Cable		Type	Conductor Cross-Sectional Area Range	Outer Diameter	Source
2	AC output power cable ^[1]		<ul style="list-style-type: none"> If you connect a ground cable to the ground point on the chassis shell, you are advised to use a three-core (L1, L2, and L3) outdoor cable and M10 OT/DT terminals (L1, L2, and L3). If you connect a ground cable to the ground point in the maintenance compartment, you are advised to use a four-core (L1, L2, L3, and PE) outdoor cable, M10 OT/DT terminals (L1, L2, and L3), and M8 OT/DT terminals (PE). You do not need to separately prepare a PE cable. 	<ul style="list-style-type: none"> Copper-core cable: <ul style="list-style-type: none"> L1, L2, L3: 25–95 mm² PE: ≥ 16 mm². For details, see Table 5-3. Aluminum alloy cable or copper-clad aluminum cable: <ul style="list-style-type: none"> L1, L2, L3: 35–95mm² PE: ≥ 16 mm². For details, see Table 5-3. 	24–57 mm	Prepared by the customer
3	Tracking system power cable		Three-core outdoor copper cable with dual-layer protection	6 mm ²	14–18 mm	Prepared by the customer
4	DC input power cable	Amphenol UTX PV Connectors	1500 V copper multi-strand twisted PV cable ^{[2][3]}	4–6 mm ² (12–10 AWG)	4.5–7.8 mm	Prepared by the customer
		MC4 EVO2 PV Connectors		4–6 mm ² (12–10 AWG)	4.7–6.4 mm	Prepared by the customer

No.	Cable	Type	Conductor Cross-Sectional Area Range	Outer Diameter	Source
<ul style="list-style-type: none"> Note [1]: When the MBUS is used for communication, it is recommended that the multi-wire cable be used. The maximum communication distance is 1000 m. If other types of AC power cables are used, contact Huawei technical support. Note [2]: Do not connect aluminum or aluminum alloy DC power cables directly to the DC terminals of the inverter. Note [3]: The 1500 V PV cables must comply with IEC 62930 or EN 50618. 					

Table 5-3 PE cable specifications

Conductor Cross-Sectional Area S of the AC Power Cable (mm^2)	Conductor Cross-Sectional Area S_p of the PE Cable (mm^2)
$16 < S \leq 35$	$S_p \geq 16$
$35 < S$	$S_p \geq S/2$
<ul style="list-style-type: none"> The specifications are valid only if the conductors of the PE cable and AC power cable use the same material. If the materials are different, ensure that the conductor cross-sectional area of the PE cable produces a conductance equivalent to that of the cable specified in the table. The specifications of the PE cable are subject to this table or calculated according to IEC 60364-5-54. 	

5.2.2 RS485 Communication

If RS485 is selected, connect an RS485 communications cable to the SUN2000, but the AC power cable does not need to connect to a SmartLogger that supports MBUS.

Figure 5-3 Network Application

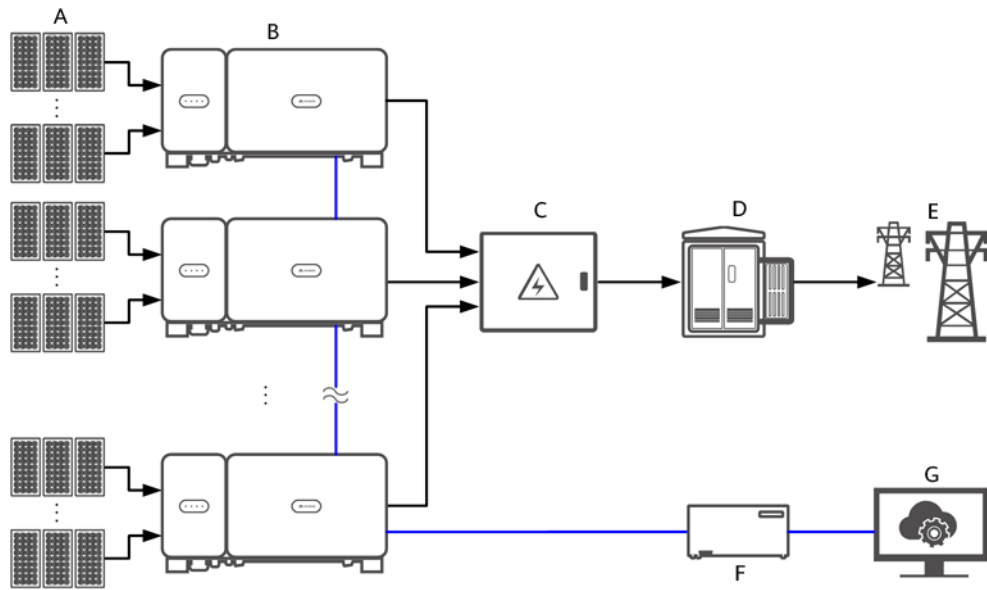

NOTE

— indicates a power cable; → indicates the power flow direction; — indicates a signal cable.

- | | | |
|-------------------------|----------------|---------------------|
| (A) PV string | (B) SUN2000 | (C) AC combiner box |
| (D) Step-up transformer | (E) Power grid | (F) SmartLogger |
| (G) Management system | - | - |

NOTICE

- To ensure the system response speed, you are advised to connect less than 30 cascading SUN2000s on each COM port of the SmartLogger.
- The RS485 communication distance between the SUN2000 at the end and the SmartLogger cannot exceed 1000 m.

Figure 5-4 SUN2000 cable connections (dashed box indicating optional components)

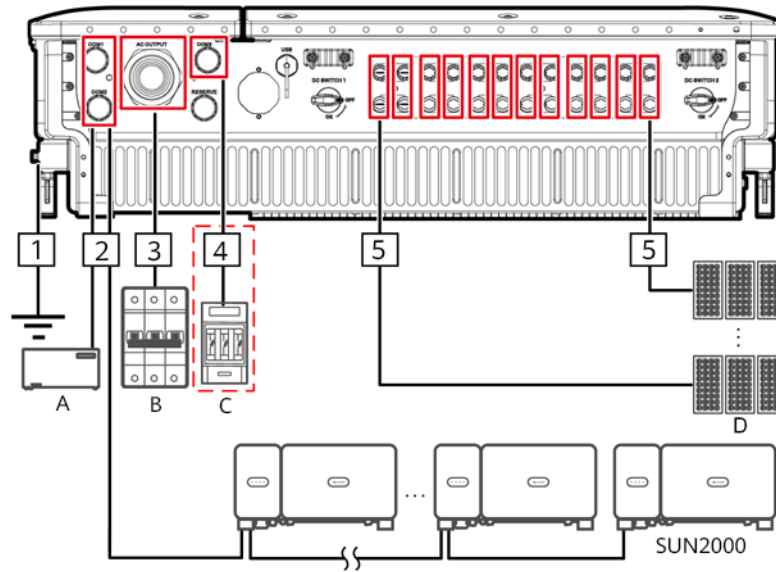

Table 5-4 Component description

No.	Component	Remarks	Source
A	SmartLogger	The SUN2000 can connect to the SmartLogger to implement RS485 communication.	Can be purchased from Huawei
B	AC switch	<ul style="list-style-type: none"> Installed in the AC combiner box It is recommended that a three-phase AC circuit breaker with a rated voltage greater than or equal to 800 V AC and a rated current of 125 A be configured for the SUN2000-105KTL-H1. It is recommended that a three-phase AC circuit breaker with a rated voltage greater than or equal to 800 V AC and a rated current of 100 A be configured for other models. 	Prepared by the customer

No.	Component	Remarks	Source
C	Fuse/Circuit breaker	<p>The tracking system should be equipped with an overcurrent protective device/component. The power cable between the device/component and wiring terminal should be no longer than 2.5 m.</p> <p>Therefore, a fuse or circuit breaker is recommended.</p> <ul style="list-style-type: none"> • Installed between the SUN2000 and tracking control box • Fuse specifications: rated voltage \geq 800 V; rated current: 6 A; protection: gG • Circuit breaker specifications: rated voltage \geq 800 V; rated current: 6 A; tripping: C 	Prepared by the customer
D	PV string	<ul style="list-style-type: none"> • A PV string is composed of PV modules connected in series. • The SUN2000 supports the input from 12 PV strings. 	Prepared by the customer

NOTICE

The SUN2000 has a residual current monitoring unit (RCMU) inside. Its external AC switch should be a three-phase circuit breaker or other AC load circuit breakers to safely disconnect the SUN2000 from the power grid.

Table 5-5 Cable description

No.	Cable	Type	Conductor Cross-Sectional Area Range	Outer Diameter	Source
1	PE cable	Single-core outdoor copper cable and M8 OT/DT terminal NOTICE Preferred to connect to the PE point on the enclosure. The PE point in the maintenance compartment is used for connecting to the PE cable included in the multi-core AC power cable.	$\geq 16 \text{ mm}^2$. For details, see Table 5-6 .	-	Prepared by the customer
2	RS485 communications cable (connected to a terminal block; recommended)	Recommended: a multi-paired, individually foil shielded cable that complies with local standards and M6 OT terminals	$0.25\text{--}2 \text{ mm}^2$	14–18 mm	Prepared by the customer
	RS485 communications cable (connected to a network port)	Recommended: a CAT 5E outdoor shielded network cable with the internal resistance $\leq 1.5 \text{ ohms}/10 \text{ m}$ ($1.5 \text{ ohms}/393.70 \text{ in.}$), as well as a shielded RJ45 connector	-	7–9 mm	Prepared by the customer

No.	Cable	Type	Conductor Cross-Sectional Area Range	Outer Diameter	Source	
3	AC output power cable	<ul style="list-style-type: none"> If you connect a ground cable to the ground point on the chassis shell, you are advised to use a three-core (L1, L2, and L3) outdoor cable and M10 OT/DT terminals (L1, L2, and L3). If you connect a ground cable to the ground point in the maintenance compartment, you are advised to use a four-core (L1, L2, L3, and PE) outdoor cable, M10 OT/DT terminals (L1, L2, and L3), and M8 OT/DT terminals (PE). You do not need to separately prepare a PE cable. 	<ul style="list-style-type: none"> Copper-core cable: <ul style="list-style-type: none"> L1, L2, L3: 25–95 mm² PE: ≥ 16 mm². For details, see Table 5-6. Aluminum alloy cable or copper-clad aluminum cable: <ul style="list-style-type: none"> L1, L2, L3: 35–95 mm² PE: ≥ 16 mm². For details, see Table 5-6. 	24–57 mm	Prepared by the customer	
4	Tracking system power cable	Three-core outdoor copper cable with dual-layer protection	6 mm ²	14–18 mm	Prepared by the customer	
5	DC input power cable	Amphe nol UTX PV Connectors	PV cable that meets the 1500 V standard	4–6 mm ² (12–10 AWG)	4.5–7.8 mm	Prepared by the customer
		MC4 EVO2 PV Connectors		4–6 mm ² (12–10 AWG)	4.7–6.4 mm	Prepared by the customer

Table 5-6 PE cable specifications

Conductor Cross-Sectional Area S of the AC Power Cable (mm ²)	Conductor Cross-Sectional Area S_p of the PE Cable (mm ²)
$16 < S \leq 35$	$S_p \geq 16$
$35 < S$	$S_p \geq S/2$
<ul style="list-style-type: none"> The specifications are valid only if the conductors of the PE cable and AC power cable use the same material. If the materials are different, ensure that the conductor cross-sectional area of the PE cable produces a conductance equivalent to that of the cable specified in the table. The specifications of the PE cable are subject to this table or calculated according to IEC 60364-5-54. 	

5.3 Installing the PE Cable

Context

NOTICE

- Proper grounding is helpful for resisting the impact of surge voltage and improving the electromagnetic interference (EMI) performance. Before connecting the AC power cable, DC power cable, and communications cable, connect the PE cable to the PE point.
- It is recommended that the PE cable of the SUN2000 be connected to a nearby PE point. Connect the PE points of all SUN2000s in the same array to ensure equipotential connections to PE cables.

Procedure

- Step 1** Connect the PE cable to the PE point.

Figure 5-5 Connecting the PE cable to the PE point (on the enclosure shell)

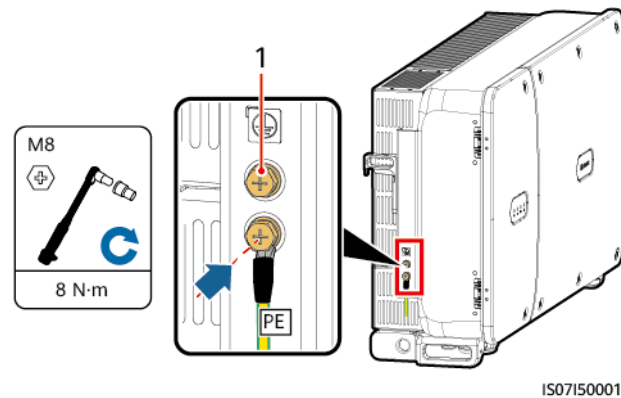

(1) Reserved PE point

----End

Follow-up Procedure

To enhance the corrosion resistance of a ground terminal, apply silica gel or paint on it after connecting the PE cable.

5.4 Opening the Maintenance Compartment Door

Precautions

CAUTION

- Do not open the host panel cover of the SUN2000.
- Before opening the maintenance compartment door, ensure that no electrical connections are made for the SUN2000 on the AC or DC side.
- If you need to open the maintenance compartment door in rainy or snowy days, take protective measures to prevent rain or snow entering the maintenance compartment. If unavoidable, do not open the maintenance compartment door.
- Do not leave unused screws in the maintenance compartment.

Procedure

Step 1 Open the maintenance compartment door and install the support bar.

Figure 5-6 Opening the maintenance compartment door

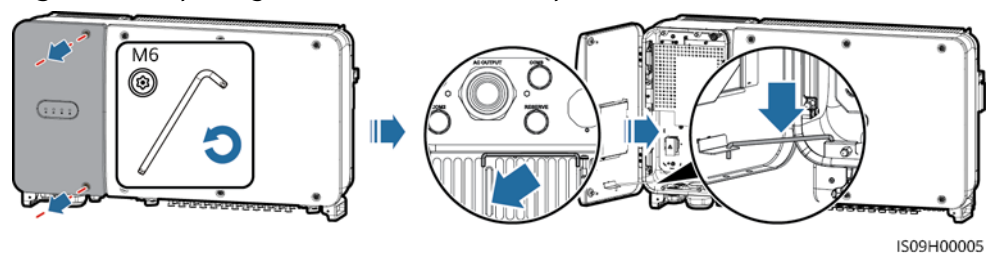

IS09H00005

Step 2 Remove the cover and hang it on the hook of the door.

Figure 5-7 Removing the cover

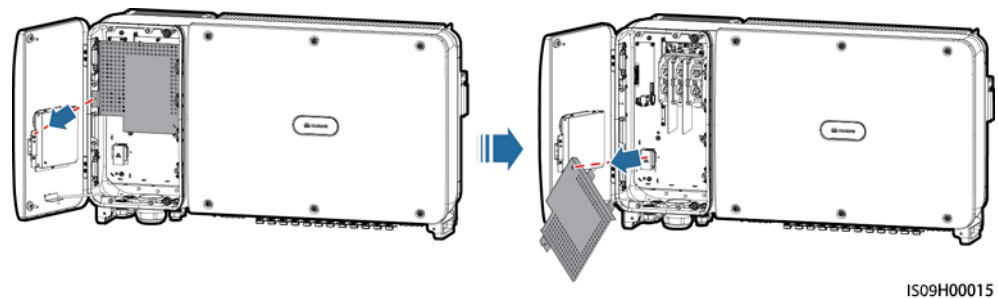

IS09H00015

----End

5.5 Connecting an AC Output Power Cable

Prerequisites

- A three-phase AC switch should be installed on the AC side of the solar inverter. To ensure that the solar inverter can safely disconnect itself from the power grid when an exception occurs, select a proper overcurrent protection device in compliance with local power distribution regulations.
- Connect the AC output power cable according to the requirements specified by local power grid operators.

Requirements for the OT/DT terminal

WARNING

- Do not connect loads between an inverter and an AC switch that directly connects to the inverter. Otherwise, the switch may trip by mistake.
 - If an AC switch is used with specifications beyond local standards, regulations, or the Company's recommendations, the switch may fail to turn off in a timely manner in case of exceptions, causing serious faults.
-

CAUTION

Each inverter shall be equipped with an AC output switch. Multiple inverters shall not connect to the same AC switch.

- If a copper cable is used, use copper wiring terminals.
- If a copper-clad aluminum cable is used, use copper wiring terminals.
- If an aluminum alloy cable is used, use copper-aluminum transition wiring terminals, or aluminum wiring terminals along with copper-aluminum transition spacers.

NOTICE

- Do not connect aluminum wiring terminals to the AC terminal block. Otherwise the electrochemical corrosion will occur and affect the reliability of cable connections.
- Comply with the IEC61238-1 requirements when using copper-aluminum transition wiring terminals, or aluminum wiring terminals along with copper-aluminum transition spacers.
- If copper-aluminum transition spacers are used, pay attention to the front and rear sides. Ensure that the aluminum sides of spacers are in contact with aluminum wiring terminals, and copper sides of spacers are in contact with the AC terminal block.

Figure 5-8 Requirements for the OT/DT terminal

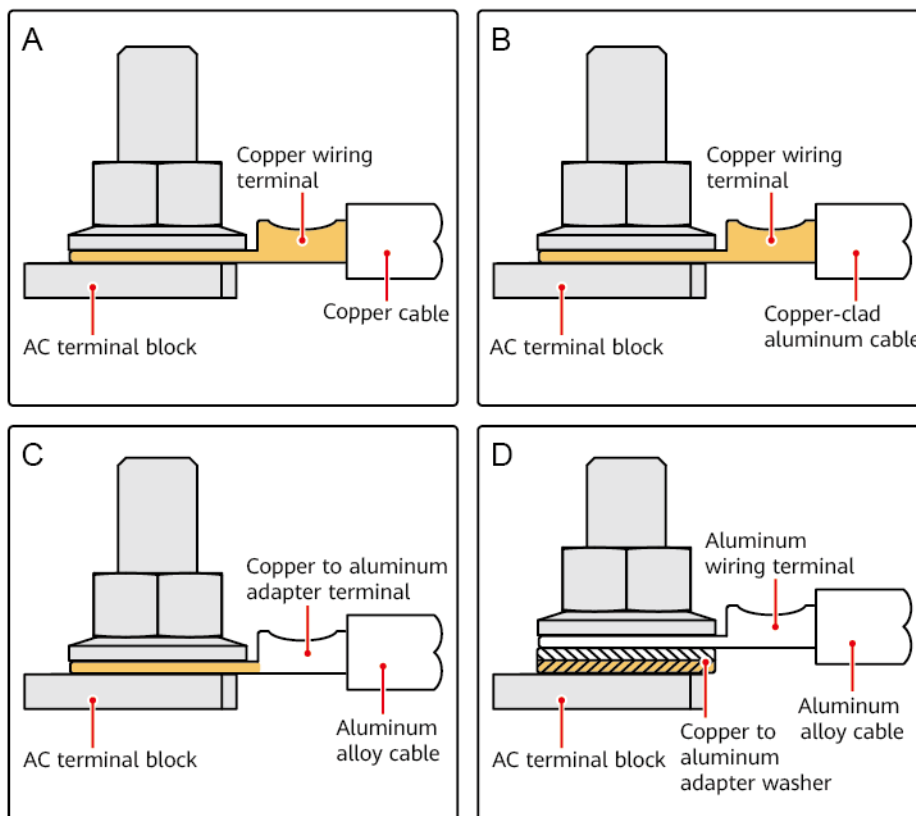

IS03H00062

Figure 5-9 AC terminal block dimensions

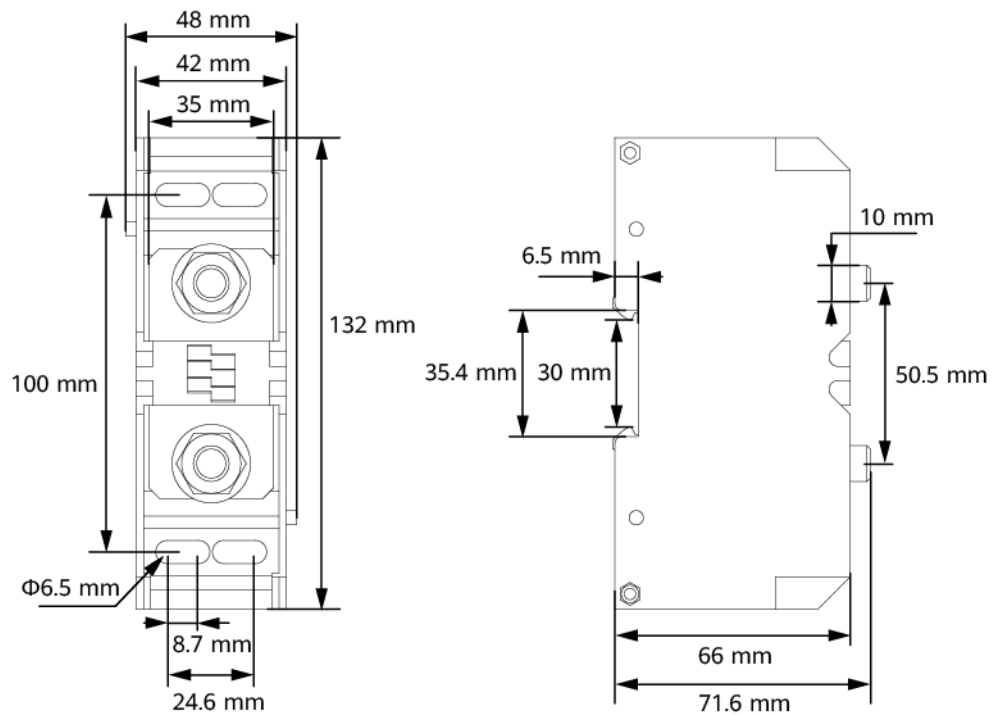

IS07W00028

NOTE

This document introduces how to install the four-core AC output power cable, which can be a reference for installing the three-core cable. The three-core cable does not need a PE cable installed in the maintenance compartment.

Procedure

- Step 1** Remove the sealing nut and rubber fitting from the waterproof connector.
- Step 2** Select an appropriate rubber fitting based on the cable outer diameter.
- Step 3** Prepare a cable and crimp OT/DT terminals.
- Step 4** Route the cable through the waterproof connector.
- Step 5** Secure the AC output power cable and PE cable.
- Step 6** Tighten the waterproof connector.

NOTICE

- Sufficient slack should be provided in the PE cable to ensure that the last cable bearing the force is the PE cable when the AC output power cable bears pulling force due to force majeure.
- If the cable outer diameter does not match the rubber liner, the IP rating of the device may be affected.
- Do not route the cable with a crimped OT/DT terminal directly through the rubber liner in case it damages the liner.
- Ensure that the cable jacket is in the maintenance compartment.
- Ensure that AC terminations are secured. Failure to do so may cause the SUN2000 to malfunction or damage to its terminal block by issues such as overheating.
- Do not adjust the cable when the sealing nut is tightened. Otherwise, the rubber liner may shift, which affects the IP rating of the device.

Figure 5-10 Installing the AC output power cable

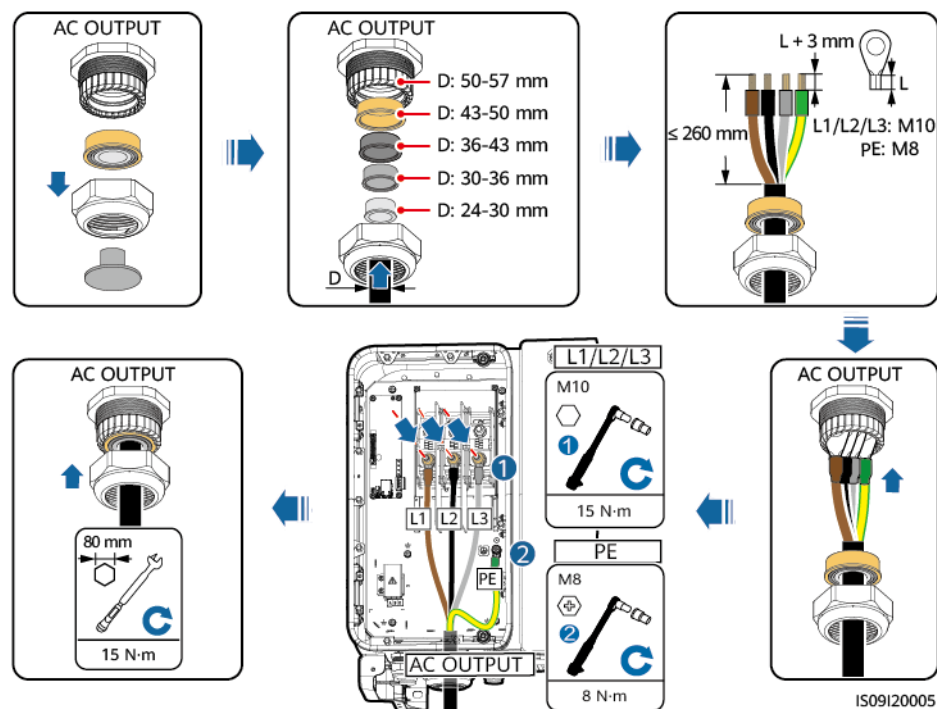

NOTE

The cable colors shown in figures are for reference only. Select an appropriate cable according to the local standards.

----End

Follow-up Procedure

Check that the cable is connected correctly and securely. Then seal the cable gland. Clear the foreign matter from the maintenance compartment.

5.6 Installing the DC Input Power Cable

Precautions

 DANGER

- Before connecting the DC input power cable, ensure that the DC voltage is within the safe range (lower than 60 V DC) and that the two DC switches on the SUN2000 are set to OFF. Failure to do so may result in electric shocks.
 - When the SUN2000 operates in grid-tied mode, do not to perform maintenance or operations on the DC circuit, such as connecting or disconnecting a PV string or a PV module in the PV string. Failure to do so may cause electric shocks or arcing, which may also cause fire.
-

 WARNING

Ensure that the following conditions are met. Otherwise, the SUN2000 may be damaged, or even a fire could happen.

- The open-circuit voltage of each PV string must always be lower than or equal to 1500 V DC.
 - The polarities of electric connections are correct on the DC input side. The positive and negative terminals of a PV module connect to corresponding positive and negative DC input terminals of the SUN2000.
-

 WARNING

During the installation of PV strings and the SUN2000, the positive or negative terminals of PV strings may be short-circuited to ground if the power cables are not properly installed or routed. In this case, an AC or DC short circuit may occur and damage the SUN2000. The resulting device damage is not covered under any warranty.

NOTICE

- Ensure that the PV module output is well insulated to ground.
 - The PV strings connecting to the same MPPT circuit should contain the same number of identical PV modules.
 - The SUN2000 does not support full parallel connection for PV strings (full parallel connection: PV strings connect to one another in parallel outside the SUN2000 and then connect to the SUN2000 independently).
-

Terminal Description

The SUN2000 provides 12 DC input terminals, which are controlled by its two DC switches. DC SWITCH 1 controls DC input terminals 1–6 (MPPT1–3) and DC SWITCH 2 controls DC input terminals 7–12 (MPPT4–6).

Figure 5-11 DC terminals

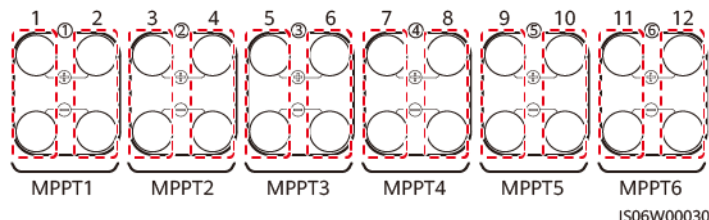

When DC inputs are not fully configured, the input terminals should meet the following requirements:

1. Evenly distribute the DC input power cable on the DC input terminals controlled by the two DC switches.
2. Maximize the number of connected MPPT circuits.

For example, if the number of input routes is 1–11, the recommended DC input terminals are as follows:

Number of PV Strings	Terminal Selection	Number of PV Strings	Terminal Selection
1	Connects to any even-number route.	2	Connects to routes 2 and 10.
3	Connects to routes 2, 6, and 10.	4	Connects to routes 2, 6, 10, and 12.
5	Connects to routes 2, 4, 6, 10, and 12.	6	Connects to routes 2, 4, 6, 8, 10, and 12.
7	Connects to routes 2, 4, 6, 8, 9, 10, and 12.	8	Connects to routes 1, 2, 4, 6, 8, 9, 10, and 12.
9	Connects to routes 1, 2, 4, 6, 7, 8, 9, 10, and 12.	10	Connects to routes 1, 2, 4, 6, 7, 8, 9, 10, 11, and 12.
11	Connects to routes 1, 2, 3, 4, 6, 7, 8, 9, 10, 11, and 12.	-	-

Requirements on Cable Specifications

Cables with high rigidity, such as armored cables, are not recommended, because poor contact may be caused by the bending of cables.

CAUTION

Use the positive and negative metal contacts and DC connectors delivered with the SUN2000. If the PV connectors are lost or damaged, purchase the connectors of the same model. The device damage caused by incompatible PV connectors is not covered under any warranty.

Procedure

- Step 1** Remove the insulation layer of the DC input power cable by an appropriate length using a wire stripper.
- Step 2** Crimp positive and negative metal contacts.
- Step 3** Insert the contacts into the corresponding positive and negative connectors.
- Step 4** Tighten the lock nuts on the positive and negative connectors.
- Step 5** Use a multimeter to measure the voltage between the positive and negative terminals of the PV string (measurement range no less than 1500 V).
 - If the voltage is a negative value, the DC input polarity is incorrect and needs correction.
 - If the voltage is greater than 1500 V, too many PV modules configured to the same string. Remove some PV modules.
- Step 6** Insert the positive and negative connectors into the corresponding DC positive and negative input terminals of the SUN2000.

Figure 5-12 Installing the DC input power cable (Amphenol UTX PV Connectors)

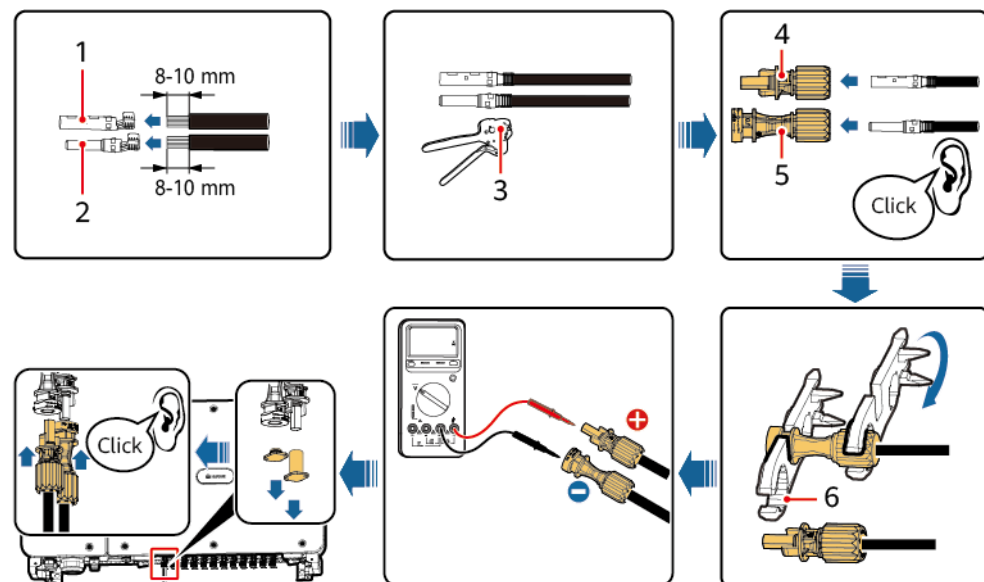

IS09130001

(1) Positive metal contact (female)

(2) Negative metal contact (male)

(3) UTXTC0003 (Amphenol)

(4) Positive connector

(5) Negative connector

(6) UTXTWA001 (Amphenol)

NOTE

Crimp the metal contacts using crimping tool UTXTC0003 (Amphenol, recommended) or UTXTC0002 (Amphenol).

Figure 5-13 Installing the DC input power cable (MC4 EVO2 PV Connectors)

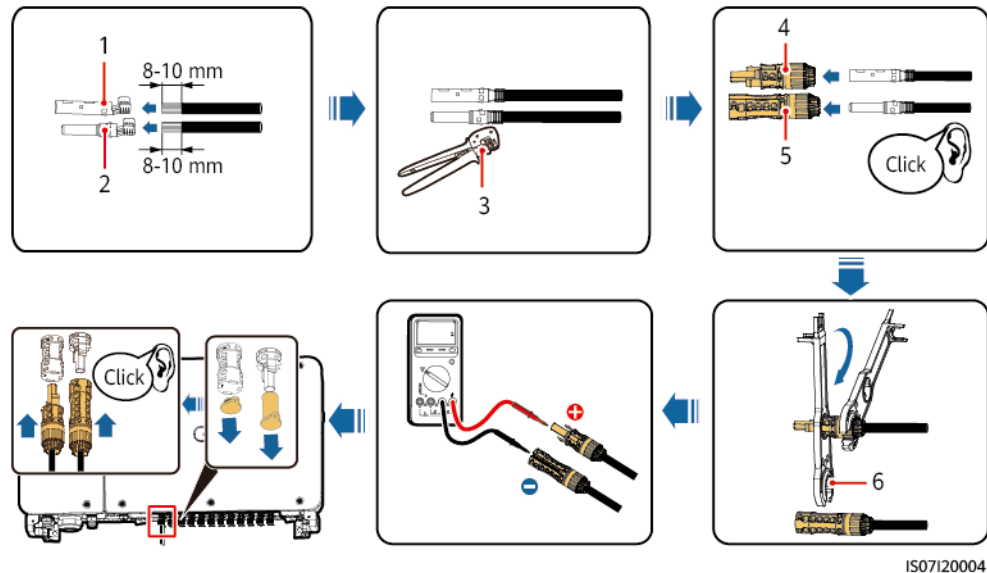

IS07120004

(1) Positive metal contact (female)

(2) Negative metal contact (male)

(3) 32.6020-22100-HZ (STAUBLI)

(4) Positive connector

(5) Negative connector

(6) 13001462 (STAUBLI)

NOTICE

If the DC input power cable is reversely connected and DC switches are set to **ON**, do not turn off the DC switches immediately or unplug positive and negative connectors. The device may be damaged if you do not follow the instruction. The caused equipment damage is beyond the warranty scope. Wait until the solar irradiance declines and the PV string current reduces to below 0.5 A, and then turn off the two DC switches and remove the positive and negative connectors. Correct the string polarity before reconnecting the string to the SUN2000.

----End

5.7 Connecting the RS485 Communications Cable

- When routing the communications cable, separate it from power cables to prevent communication from being affected. Connect the shield layer to the PE point.
- Connect the RS485 communications cable to either a terminal block (recommended) or an RJ45 network port.

Connecting to a Terminal Block (Recommended)

Figure 5-14 Connecting the RS485 communications cable (to a terminal block)

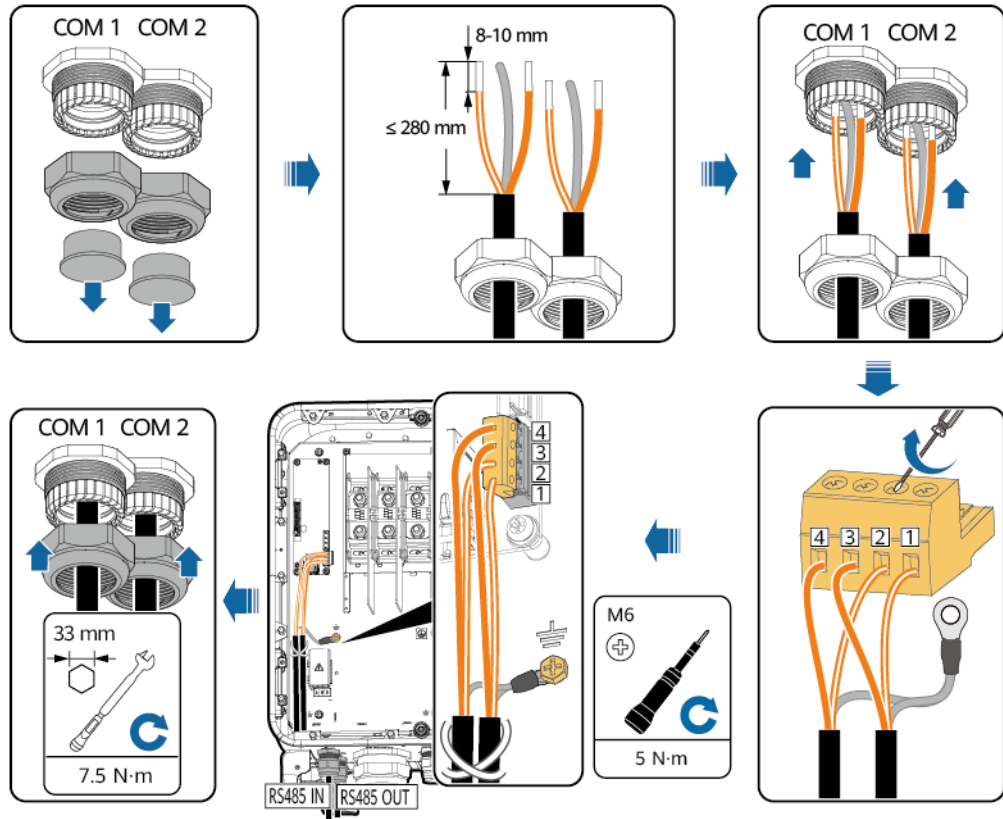
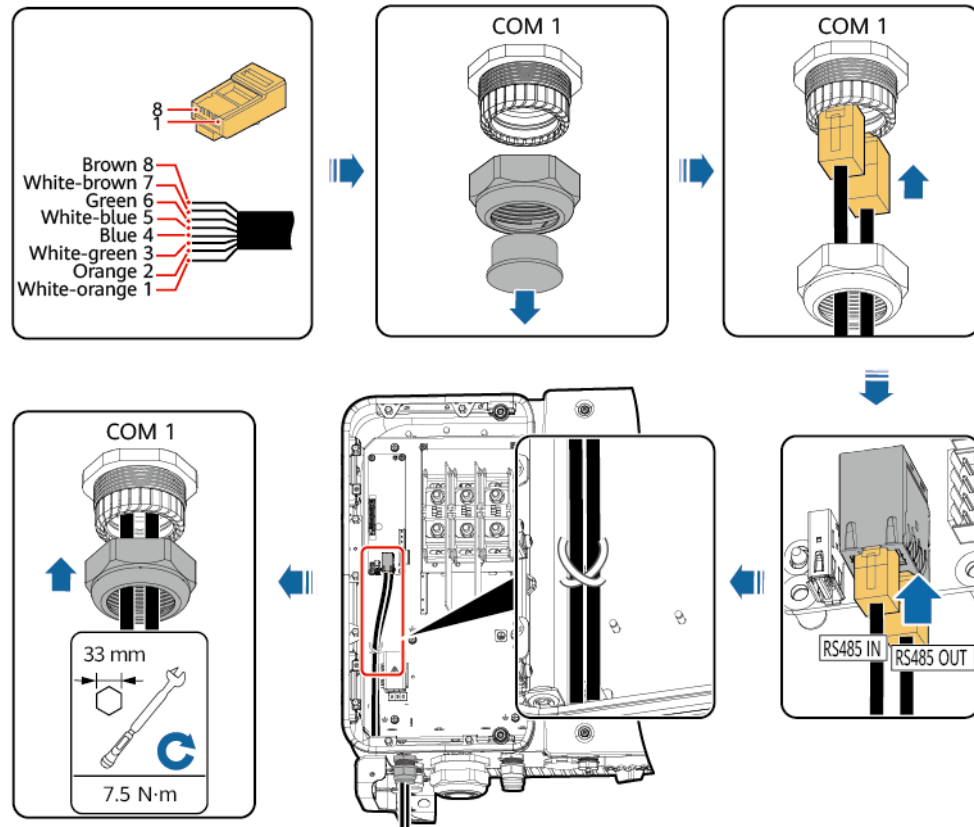

Table 5-7 Terminal block description

No.	Definition	Description
1	RS485A IN	RS485A, RS485 differential signal+
2	RS485A OUT	RS485A, RS485 differential signal+
3	RS485B IN	RS485B, RS485 differential signal-
4	RS485B OUT	RS485B, RS485 differential signal-

Connecting to an RJ45 Network Port

Figure 5-15 Connecting the RS485 communications cable (to an RJ45 network port)



IS09140001

Table 5-8 RJ45 network port description

No.	Description	No.	Description
1, 4	RS485A, RS485 differential signal+	2, 5	RS485B, RS485 differential signal-

Follow-up Operations

Check that the cable is connected correctly and securely. Then seal the cable gland. Clear the foreign matter from the maintenance compartment.

5.8 (Optional) Installing the Power Cable of the Tracking System

Precautions

The tracking system should be equipped with an overcurrent protective device/component. The power cable between the device/component and wiring terminal should be no longer than 2.5 m.

WARNING

- The tracking system is powered by the three-phase AC power grid with a rated voltage of 800 V.
 - Keep inflammable materials away from the power cable.
 - The power cable must be protected with a conduit to prevent short circuits caused by insulation layer damage.
-
- If there is a power port for the tracking system in the maintenance compartment of the inverter, connect the power cable of the tracking system to the power port.
 - If there is no power port, connect the power cable to the AC terminal block.

Connecting the Power Cable to the Power Port for the Tracking System

Step 1 Remove the sealing nut from the cable gland.

Step 2 Prepare a cable.

Step 3 Route the cable through the cable gland.

Step 4 Connect the power cable of the tracking system.

Step 5 Bind the power cable of the tracking system.

Step 6 Tighten the cable gland.

Figure 5-16 Connecting the power cable of the tracking system

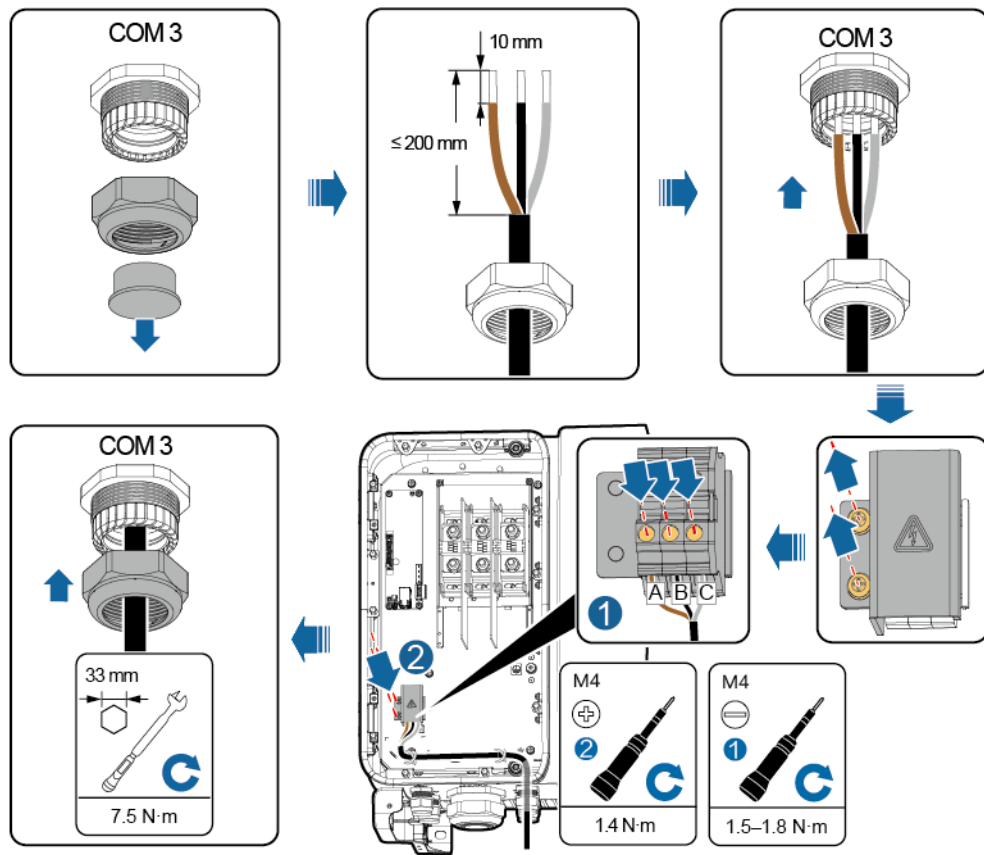

IS09120003

----End

Connecting the Power Cable to the AC Terminal Block

NOTE

You need to prepare the M10 OT terminal before installing the power cable of the tracking system to the AC terminal block.

- Step 1** Remove the sealing nut from the cable gland.
- Step 2** Prepare a cable.
- Step 3** Route the cable through the cable gland.
- Step 4** Connect the power cable of the tracking system.

NOTICE

Connect the OT/DT terminal of the AC output cable and the OT terminal of the power cable of the tracking system to the AC terminal block with the latter placed on top of the former. Ensure that the terminals are separated in the wiring area and are connected securely.

- Step 5** Tighten the cable gland.

Figure 5-17 Connecting the power cable of the tracking system

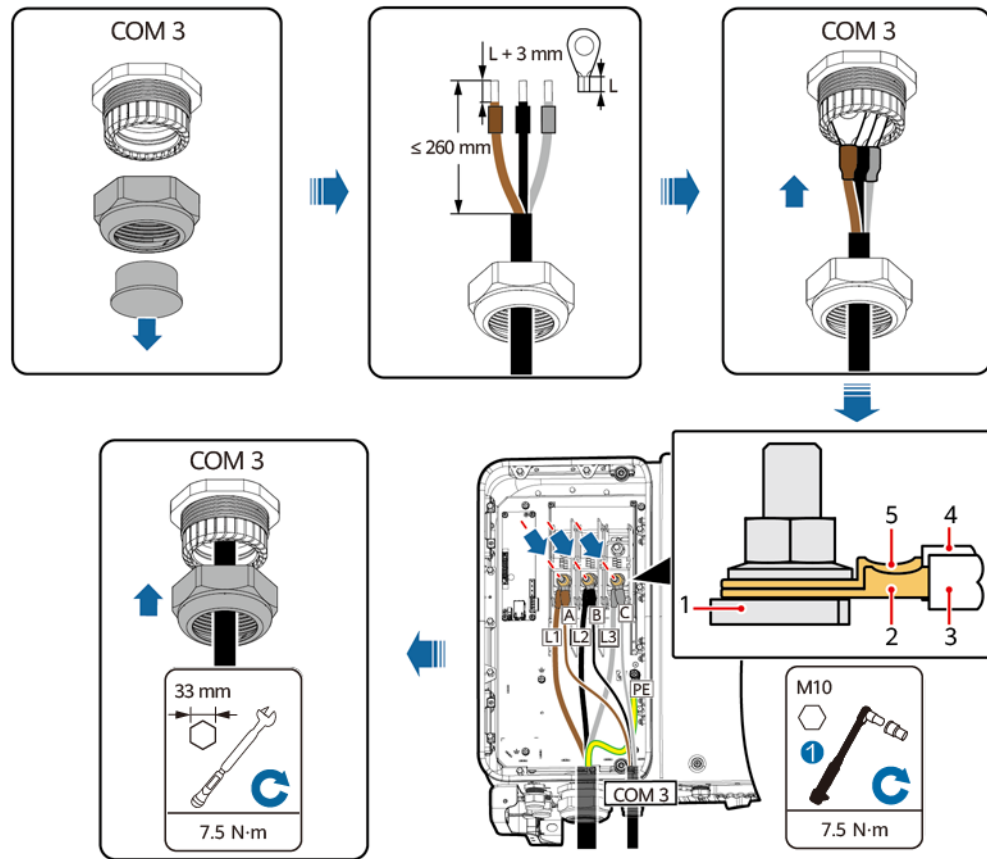

IS09I20009

- (1) AC terminal block (2) OT/DT terminal of the AC (3) AC output power cable
output power cable
- (4) Power cable of the tracking system (5) OT terminal of the power cable of the tracking system

----End

Follow-up Operations

Check that the cable is connected correctly and securely. Then seal the cable gland. Clear the foreign matter from the maintenance cavity.

5.9 Closing the Maintenance Compartment Door

Procedure

- Step 1** Install the AC terminal cover and then install the support bar.
- Step 2** Close the maintenance compartment door and tighten the two screws on the door.

Figure 5-18 Closing the maintenance compartment door

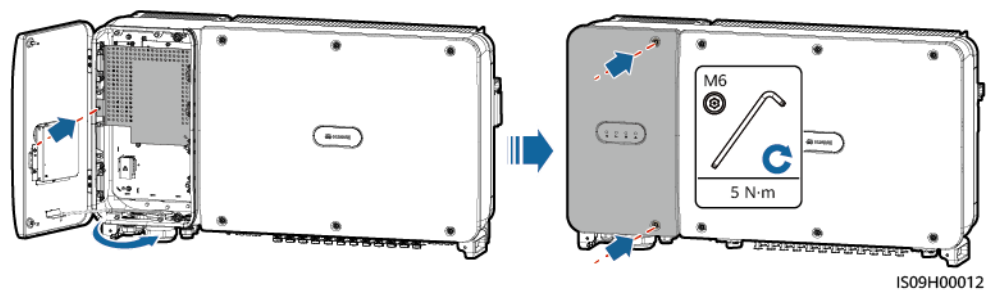

NOTE

If the screws on the door are lost, use the spare screws in the fitting bag at the bottom of the enclosure.

----End

6 Commissioning

Prerequisites

 **DANGER**

- Wear personal protective equipment and use dedicated insulated tools to avoid electric shocks or short circuits.

6.1 Checking Before Power-On

No.	Acceptance Criteria
1	The SUN2000 is installed correctly and securely.
2	DC switches and the downstream AC switch are OFF.
3	All cables are connected correctly and securely.
4	Used cable glands are sealed and locking caps are tightened.
5	Unused terminals and ports are locked by watertight caps.
6	The installation space is proper, and the installation environment is clean and tidy, without foreign matter.
7	The AC terminal cover is reinstalled.
8	The maintenance compartment door is closed and the door screws are tightened.

6.2 Powering On the SUN2000

Precautions

DANGER

- Wear personal protective equipment and use dedicated insulated tools to avoid electric shocks or short circuits.
-

NOTICE

- Before the equipment is put into operation for the first time, ensure that the parameters are set correctly by professional personnel. Incorrect parameter settings may result in noncompliance with local grid connection requirements and affect the normal operations of the equipment.
 - Before turning on the AC switch between the SUN2000 and the power grid, use a multimeter set to the AC position to check that the AC voltage is within the specified range.
 - If the solar inverter has not been running for more than half a year after being mounted, it must be checked and tested by professionals before being put into operation.
-

Procedure

- Step 1** Turn on the AC switch between the SUN2000 and the power grid.

NOTICE

If you perform [Step 2](#) before [Step 1](#), the SUN2000 reports a fault about abnormal shutdown. You can start the SUN2000 only after the fault is automatically rectified.

- Step 2** Turn on the DC switches at the bottom of the SUN2000.
- Step 3** Perform quick settings on the app. For details, see [7 Man-Machine Interactions](#).

----End

7 Man-Machine Interactions

7.1 Operations with the SUN2000 App

7.1.1 App Introduction

Functions

- The FusionSolar app is recommended when the SUN2000 is connected to the FusionSolar Smart PV Management System (SmartPVMS). The SUN2000 app is recommended when the SUN2000 is connected to other management systems.
- The SUN2000 or FusionSolar app (app for short) is a mobile phone app that communicates with the SUN2000 over a WLAN/Bluetooth module or a USB data cable to allow for querying alarms, setting parameters, and performing routine maintenance as an easy-to-use maintenance platform.

Connection Mode

After the DC or AC side of the SUN2000 is powered on, you can connect the app to it through a WLAN module, a Bluetooth module or a USB data cable.

NOTICE

- Over a WLAN module: The USB-Adapter2000-C WLAN module is supported.
 - Over a Bluetooth module: The USB-Adapter2000-B Bluetooth module is supported.
 - Over a USB data cable: The USB 2.0 port is supported. Use the USB data cable delivered with the mobile phone.
 - Mobile phone operating system: Android 4.0 or later.
 - Recommended phone brands: Huawei and Samsung.
-

Figure 7-1 Connection over a WLAN module or a Bluetooth module

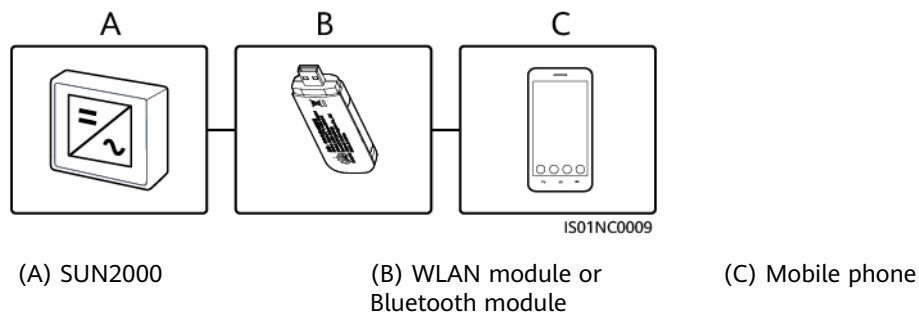
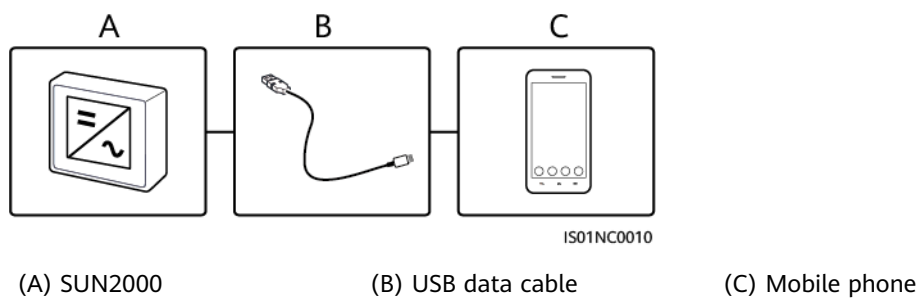

Figure 7-2 Connection over a USB data cable



Disclaimer

NOTICE

- The configurable parameters of the SUN2000 vary with the device model and grid code.
- If you change the grid code, some parameters may be restored to factory defaults. After the grid code is changed, check whether the previously set parameters are affected.
- Delivering a reset, factory reset, shutdown, or upgrade command to the solar inverters may cause power grid connection failure, which affects the energy yield.
- Before the equipment is put into operation for the first time, ensure that the parameters are set correctly by professional personnel. Incorrect parameter settings may result in noncompliance with local grid connection requirements and affect the normal operations of the equipment.
- The parameter names, value ranges, and default values are subject to change.

7.1.2 Downloading and Installing the App

- FusionSolar app: Scan the QR code and download the latest installation package.
- SUN2000 app: Log in to Huawei AppGallery , search for **SUN2000**, and download the app installation package. You can also scan the QR code to download the installation package.

QR code:



FusionSolar



SUN2000 (Android)



SUN2000 (iOS)

7.1.3 Logging In to the App

Prerequisites

- The DC or AC side of the SUN2000 has been energized.
- Connection over a WLAN module or a Bluetooth module:
 - a. The WLAN module or Bluetooth module is connected to the **USB** port at the bottom of the SUN2000.
 - b. The WLAN or Bluetooth function is enabled.
 - c. Keep the mobile phone within 5 m from the SUN2000. Otherwise, the communication between them would be affected.
- Connection over a USB cable:
 - a. The USB data cable is connected from the USB port at the bottom of the SUN2000 to the port on the mobile phone.
 - b. If the USB data cable is successfully connected, the message **Connected to USB Accessory** will pop up on the phone. Otherwise, the cable is not connected.

Procedure

1. Run the app and select a connection mode.

NOTE

- The screenshots in this document correspond to the SUN2000 app 3.2.00.013 (Android) and FusionSolar app 5.7.010 (Android).
- When the WLAN connection is used, scan the QR code of the WLAN module to access the login screen.
- When the WLAN connection is used, the initial name of the WLAN hotspot is **Adapter-WLAN module SN**, and the initial password is **Changeme**. Use the initial password upon first power-on and change it immediately after login. To ensure account security, change the password periodically and keep the new password in mind. Not changing the initial password may cause password disclosure. A password left unchanged for a long period of time may be stolen or cracked. If a password is lost, devices cannot be accessed. In these cases, the user is liable for any loss caused to the PV plant.
- When the Bluetooth connection is used, the connected Bluetooth device is named after **last 8 digits of the SN barcode+HWAPP**.
- After you select **Use by default for this USB accessory**, a message that asks you to confirm the USB access will not appear if you log in to the app again without removing the USB data cable.

- a. (Scenario in which the SUN2000 is connected to the FusionSolar SmartPVMS) Run the FusionSolar app and access the **Device Commissioning** screen.

Figure 7-3 Selecting a connection mode (with network access)

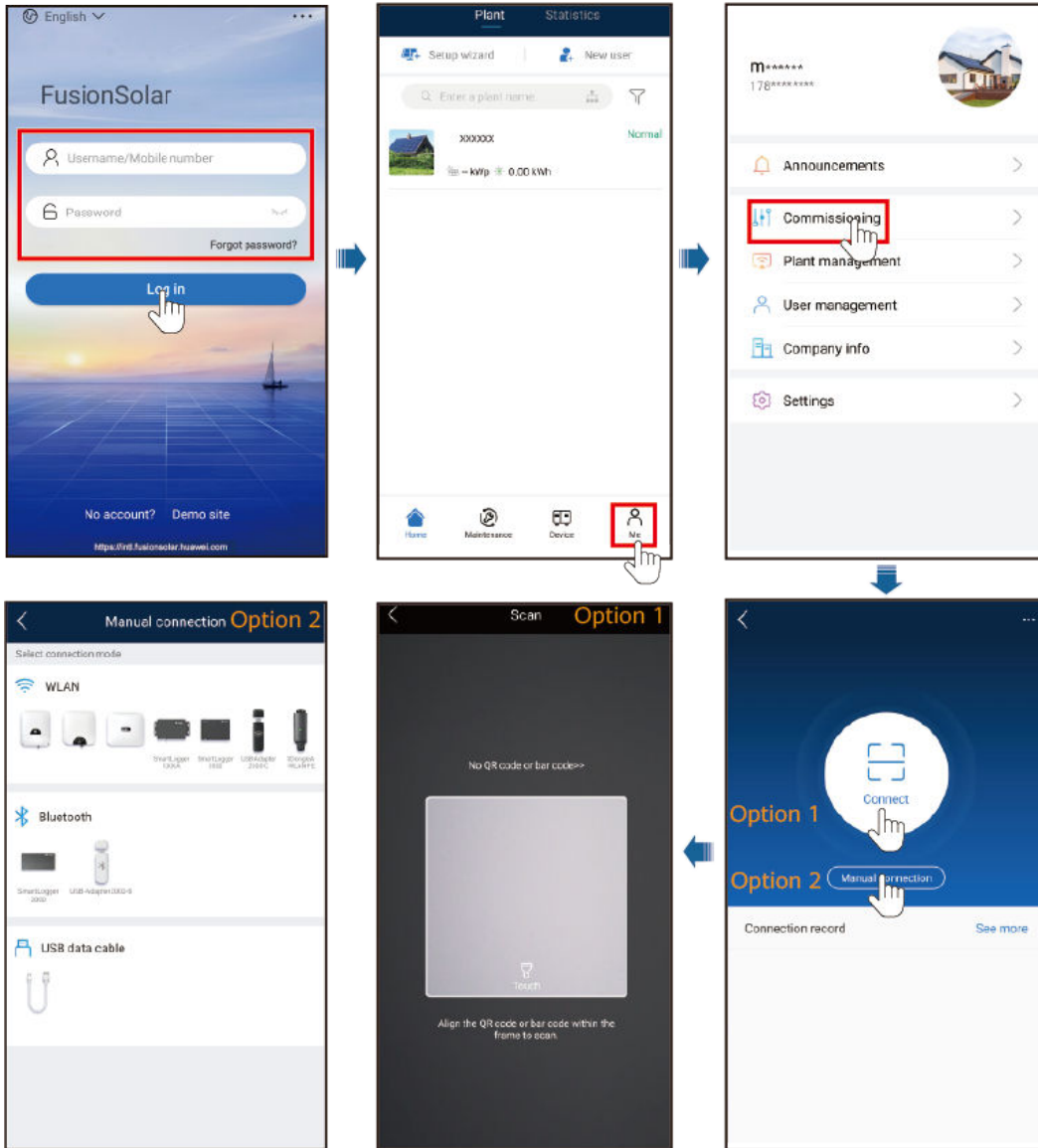
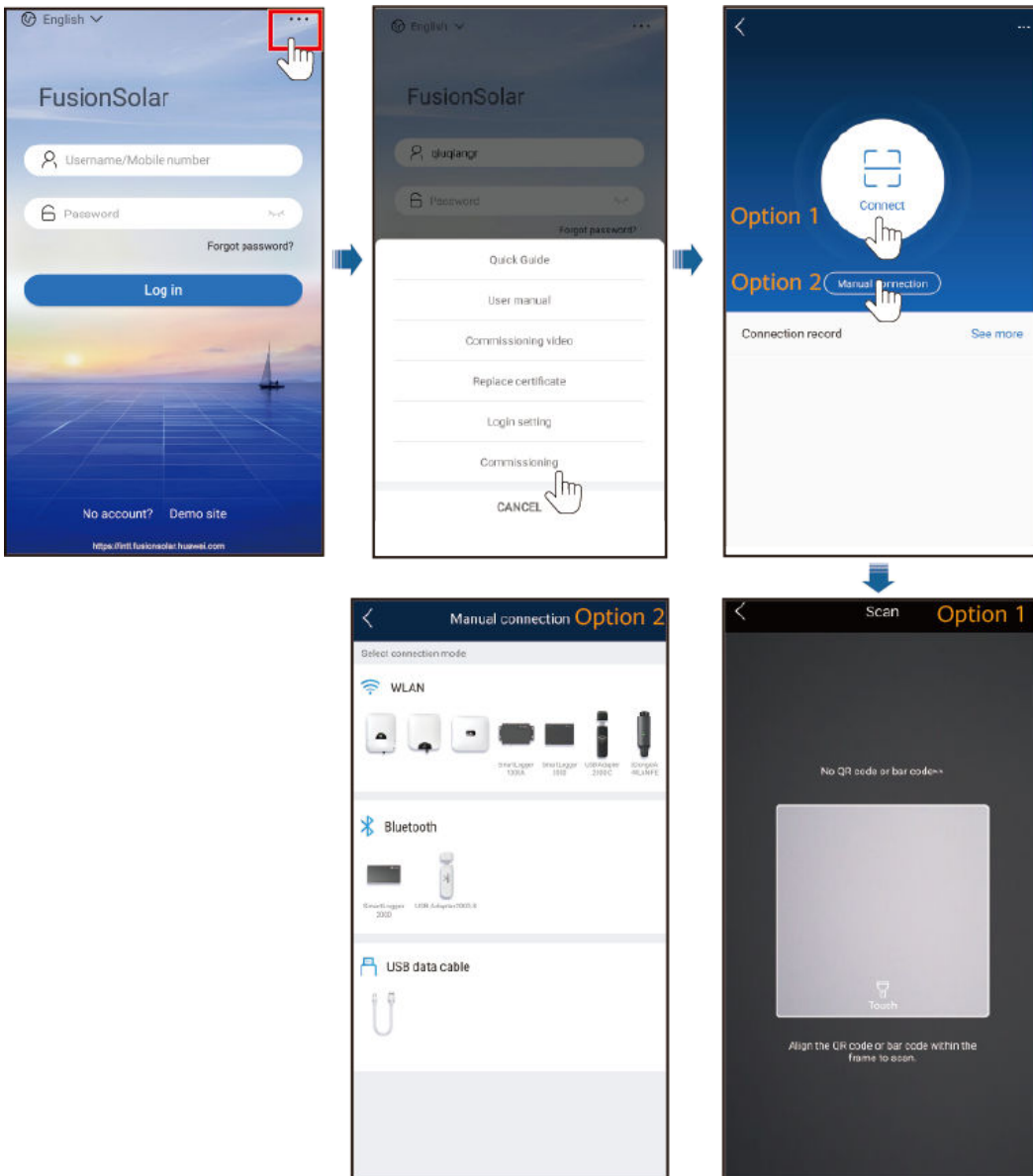
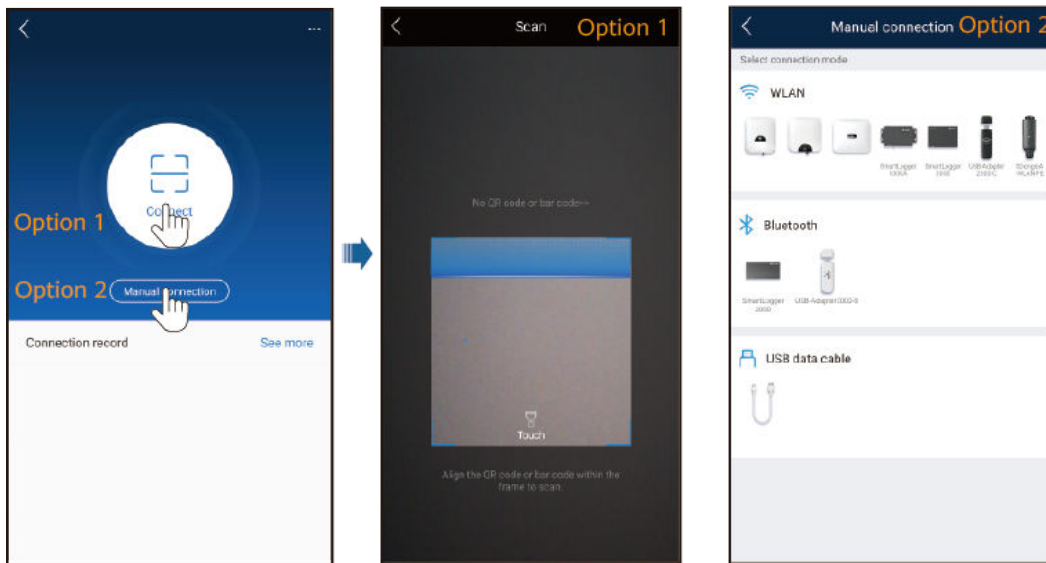

Figure 7-4 Selecting a connection mode (without network access)



- b. (Scenario in which the SUN2000 is connected to other management systems) Run the SUN2000 app and access the operation screen.

Figure 7-5 Selecting a connection method



2. Select a login user and enter the login password to access the quick settings screen or the main menu screen.

NOTICE

- The login password is the same as that for the SUN2000 connected to the app and is used only when the SUN2000 connects to the app.
- The initial passwords for **Common User**, **Advanced User**, and **Special User** are all **00000a**.
- Use the initial password upon first power-on and change it immediately after login. To ensure account security, change the password periodically and keep the new password in mind. Not changing the initial password may cause password disclosure. A password left unchanged for a long period of time may be stolen or cracked. If a password is lost, devices cannot be accessed. In these cases, the user is liable for any loss caused to the PV plant.
- During the login, if five consecutive invalid password entries are made (the interval between two consecutive entries is less than 2 minutes), the account will be locked for 10 minutes. The password should consist of six characters.
- If you log in to the app after the device connects to the app for the first time or factory defaults are restored, the quick settings screen will be displayed. Set basic parameters as prompted. If you do not set basic parameters for the inverter on the quick settings screen, the screen is still displayed when you log in to the app next time.
- To set SUN2000 basic parameters on the quick settings screen, switch to **Advanced User**. If you log in as **Common User** or **Special User**, enter the password of the advanced user to access the **Quick Settings** screen.

Figure 7-6 Login

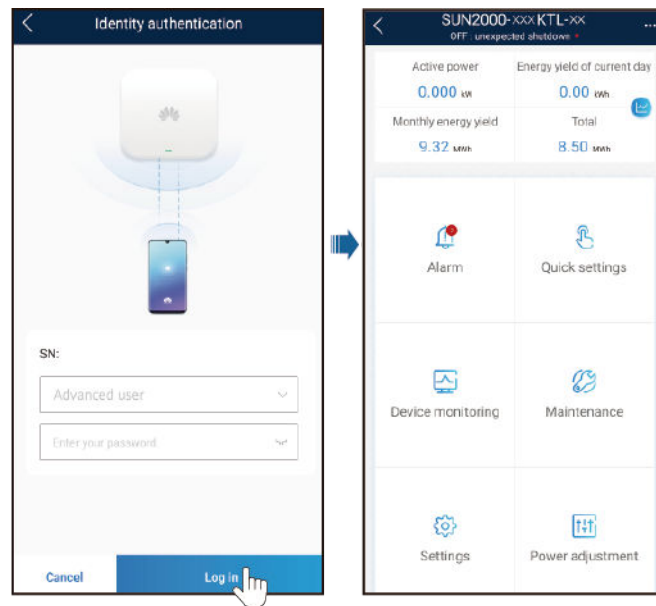

7.1.4 Operations Related to the Advanced User

Ensure that the DC side of the SUN2000 is energized before setting grid parameters, protection parameters, and feature parameters.

7.1.4.1 Setting Grid Parameters

Procedure

Step 1 Choose **Settings > Grid parameters** to set grid parameters.

Figure 7-7 Grid parameters

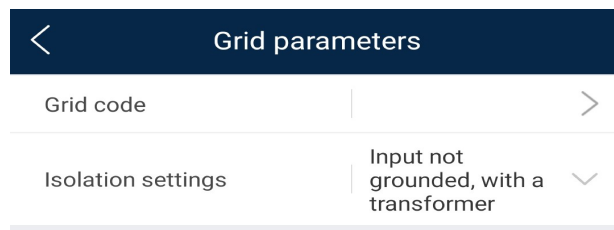

Table 7-1 Grid parameters

Parameter	Description
Grid Code	Set this parameter based on the grid code of the country or region where the inverter is used and the inverter application scenario.
Isolation settings	Set the working mode of the inverter based on the grounding status at DC side and the connection to the power grid.

----End

7.1.4.2 Setting Protection Parameters

Procedure

Step 1 Choose **Settings > Protection parameters** to set protection parameters.

Figure 7-8 Protection parameters

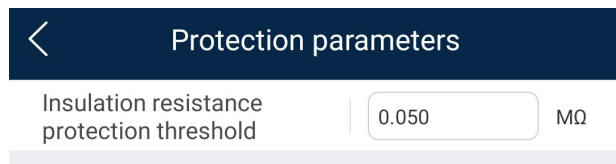

Table 7-2 Protection parameters

Parameter	Description
Insulation resistance protection threshold (MΩ)	To ensure device safety, the inverter detects the insulation resistance of the input side with respect to ground when it starts a self-check. If the detected value is less than the preset value, the inverter does not connect to the grid.

----End

7.1.4.3 Setting Feature Parameters

Procedure

Step 1 Choose **Settings > Feature parameters** to set feature parameters.

Figure 7-9 Feature parameters

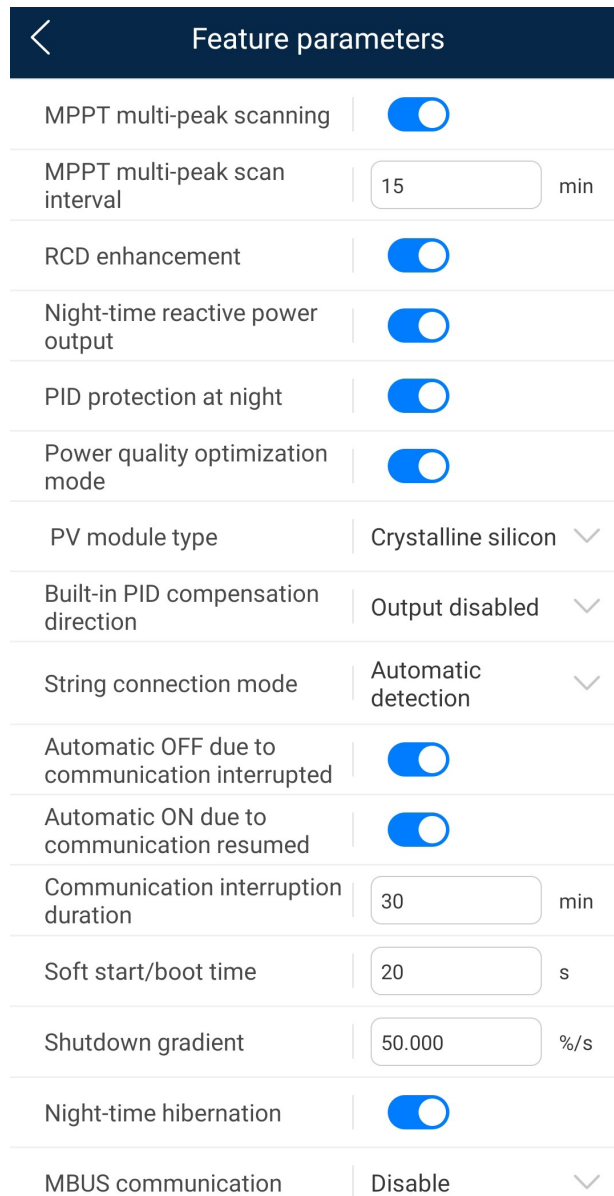

Table 7-3 Feature parameters

Parameter	Description
MPPT multi-peak scanning	When the inverter is used in scenarios where PV strings are greatly shaded, set this parameter to Enable , and then the inverter will perform MPPT scanning at regular intervals to locate the maximum power.
MPPT multi-peak scan interval (min)	Specifies the MPPT scanning interval. This parameter is displayed when MPPT multi-peak scanning is set to Enable .

Parameter	Description
RCD enhancement	RCD refers to the residual current of the inverter to the ground. To ensure device and personal safety, RCD should be limited to the specified value in the standard. If an AC switch with a residual current detection function is installed outside the inverter, this function should be enabled to reduce the residual current generated when the inverter is running, thereby preventing the AC switch from misoperations.
Night-time reactive power output	In some specific application scenarios, a power grid company requires that the inverter can perform reactive power compensation at night to ensure that the power factor of the local power grid meets requirements. This parameter is displayed when Isolation settings is set to Input ungrounded, with TF .
PID protection at night	When the inverter outputs reactive power at night and this parameter is set to Enable , the inverter will shut down automatically if it detects abnormal status of the PID compensation.
Power quality optimization mode	If this parameter is set to Enable , the inverter output current harmonics will be optimized.
PV module type	This parameter is used to set different types of PV modules and the shutdown time of the concentration PV module. If the concentration PV modules are shaded, the power drops drastically to 0 and the inverter shuts down. The energy yield would be affected since it takes too long for the power to resume and inverter to restart. The parameter does not need to be set for crystalline silicon and filmy PV modules. <ul style="list-style-type: none"> ● If this parameter is set to Crystalline silicon or Film, the inverter automatically detects the power of PV modules when they are shaded and shuts down if the power is too low. ● When concentration PV modules are used: <ul style="list-style-type: none"> – If this parameter is set to CPV 1, the inverter can quickly restart in 60 minutes if the input power of PV modules drops drastically due to shading. – If this parameter is set to CPV 2, the inverter can quickly restart in 10 minutes if the input power of PV modules drops drastically due to shading.
PID compensation direction (or Crystalline silicon PV compensation mode)	When the external PID module compensates the PID voltage for the PV system, set Built-in PID compensation direction to the actual compensation direction of the PID module so that the inverter can output reactive power at night. This parameter is displayed when PV module type is set to Crystalline silicon . Select PV-positive offset for P-type PV modules. Select PV+ negative offset for N-type PV modules.

Parameter	Description
String connection mode	<p>Set the connection mode of PV strings.</p> <ul style="list-style-type: none"> When PV strings connect to the SUN2000 separately (fully separate connection), there is no need to set this parameter. The SUN2000 can automatically detect the connection mode of the PV strings. When PV strings connect to one another in parallel outside the SUN2000 and then connect to SUN2000 independently (fully parallel connection), set this parameter to All PV strings connected.
Automatic OFF due to communication interrupted	<p>The standards of certain countries and regions require that the inverter must shut down after the communication is interrupted for a certain time.</p> <p>If Automatic OFF due to communication interrupted is set to Enable and the inverter communication is interrupted for a specified time (set by Communication interruption duration), the inverter will automatically shut down.</p> <p>NOTICE Setting this parameter to Enable may cause power grid connection failure of the solar inverters, which affects the energy yield.</p>
Automatic ON due to communication resumed	<p>If this parameter is set to Enable, the inverter automatically starts after communication recovers. If this parameter is set to Disable, the inverter needs to be started manually after communication recovers.</p> <p>This parameter is displayed when Automatic OFF due to communication interrupted is set to Enable.</p>
Communication interruption duration (min)	<p>Specifies the duration for determining communication interruption. Used for automatic shutdown for protection in case of communication interruption.</p>
Soft start/boot time (s)	<p>Specifies the duration for the power to gradually increase when the inverter starts.</p>
Shutdown gradient (%/s)	<p>Specifies the power change speed when the inverter shuts down.</p>
Night-time hibernation	<p>The inverter monitors PV strings at night. If this parameter is set to Enable, the monitoring function of the inverter will hibernate at night to reduce power consumption.</p>
MBUS communication	<p>For inverters that support RS485 communication and MBUS communication, you are advised to set this parameter to Disable to reduce power consumption.</p>

Parameter	Description
Delay upgrade	<p>This parameter is mainly used in the upgrade scenarios where the PV power supply is disconnected at night due to no sunlight or unstable at dawn or dusk due to poor sunlight.</p> <p>After the inverter starts to upgrade, if Delay upgrade is set to Enable, the upgrade package is loaded first. After the PV power supply recovers and the activation conditions are met, the inverter automatically activates the upgrade.</p>
RS485-2 communication	<p>If this parameter is set to Enable, the RS485-2 port can be used. If the port is not used, you are advised to set this parameter to Disable to reduce power consumption.</p>
String monitor	<p>The inverter monitors PV strings in real time. If any PV string is abnormal (such as the PV string is shaded or the electric energy yield decreases), the inverter generates an alarm to remind maintenance personnel to maintain the PV string in a timely manner.</p> <p>If PV strings are often shaded, you are advised to set String monitor to Disable to prevent false alarms.</p>
String detection reference asymmetric coefficient	<p>Specifies the threshold for determining PV string exception. The false alarms caused by fixed shadow shading can be controlled by changing this parameter.</p> <p>This parameter is displayed when String monitor is set to Enable.</p>
String detection starting power percentage (%)	<p>Specifies the threshold for starting PV string exception detection. The false alarms caused by fixed shadow shading can be controlled by changing this parameter.</p> <p>This parameter is displayed when String monitor is set to Enable.</p>
Duration for determining short-time grid disconnection (ms)	<p>The standards of certain countries and regions require that the inverter should not disconnect from the power grid if the power grid experiences a short-time failure. After the fault is rectified, the inverter output power needs to be quickly restored.</p>

----End

7.1.5 Operations Related to the Special User

Ensure that the DC side of the SUN2000 is energized before setting grid parameters, protection parameters, feature parameters, and grid adjustment parameters.

7.1.5.1 Setting Grid Parameters

Procedure

Step 1 Choose **Settings > Grid parameters** to set grid parameters.

Figure 7-10 Grid parameters

Table 7-4 Grid parameters

Parameter	Description
Grid Code	Set this parameter based on the grid code of the country or region where the inverter is used and the inverter application scenario.
Isolation settings	Set the working mode of the inverter based on the grounding status at DC side and the connection to the power grid.

Parameter	Description
Output mode	Specifies whether the inverter output has a neutral wire based on the application scenario.
Automatically start upon grid recovery	Specifies whether to allow the inverter to automatically start after the power grid recovers.
Grid connected recovery time from grid faults (s)	Specifies the time after which the inverter begins restarting after the power grid recovers.
Startup voltage lower threshold of grid connection (V)	According to the standards of certain countries and regions, after the inverter is powered on for the first time for grid connection, if the power grid voltage is lower than Startup voltage lower threshold of grid connection , the inverter is not allowed to connect to the grid.
Startup frequency upper threshold of grid connection (Hz)	According to the standards of certain countries and regions, after the inverter is powered on for the first time for grid connection, if the power grid voltage is higher than Startup frequency upper threshold of grid connection , the inverter is not allowed to connect to the grid.
Startup frequency lower threshold of grid connection (Hz)	According to the standards of certain countries and regions, after the inverter is powered on for the first time for grid connection, if the power grid voltage is lower than Startup frequency lower threshold of grid connection , the inverter is not allowed to connect to the grid.
Grid reconnection voltage upper limit (V)	The standards of certain countries and regions require that after the inverter shuts down for protection due to a fault, if the power grid voltage is higher than Grid reconnection voltage upper limit , the inverter is not allowed to reconnect to the grid.
Grid reconnection voltage lower limit (V)	The standards of certain countries and regions require that after the inverter shuts down for protection due to a fault, if the power grid voltage is lower than Grid reconnection voltage lower limit , the inverter is not allowed to reconnect to the grid.
Grid reconnection frequency upper limit (Hz)	The standards of certain countries and regions require that after the inverter shuts down for protection due to a fault, if the power grid frequency is higher than Grid reconnection frequency upper limit , the inverter is not allowed to reconnect to the grid.
Grid reconnection frequency lower limit (Hz)	The standards of certain countries and regions require that after the inverter shuts down for protection due to a fault, if the power grid frequency is lower than Grid reconnection frequency lower limit , the inverter is not allowed to reconnect to the grid.
Reactive power compensation (cos ϕ -P) trigger voltage (%)	Specifies the voltage threshold for triggering reactive power compensation based on the cos ϕ -P curve.
Reactive power compensation (cos ϕ -P) exit voltage (%)	Specifies the voltage threshold for exiting reactive power compensation based on the cos ϕ -P curve.

----End

7.1.5.2 Setting Protection Parameters

Procedure

Step 1 Choose **Settings > Protection parameters** to set protection parameters.

Figure 7-11 Protection parameters

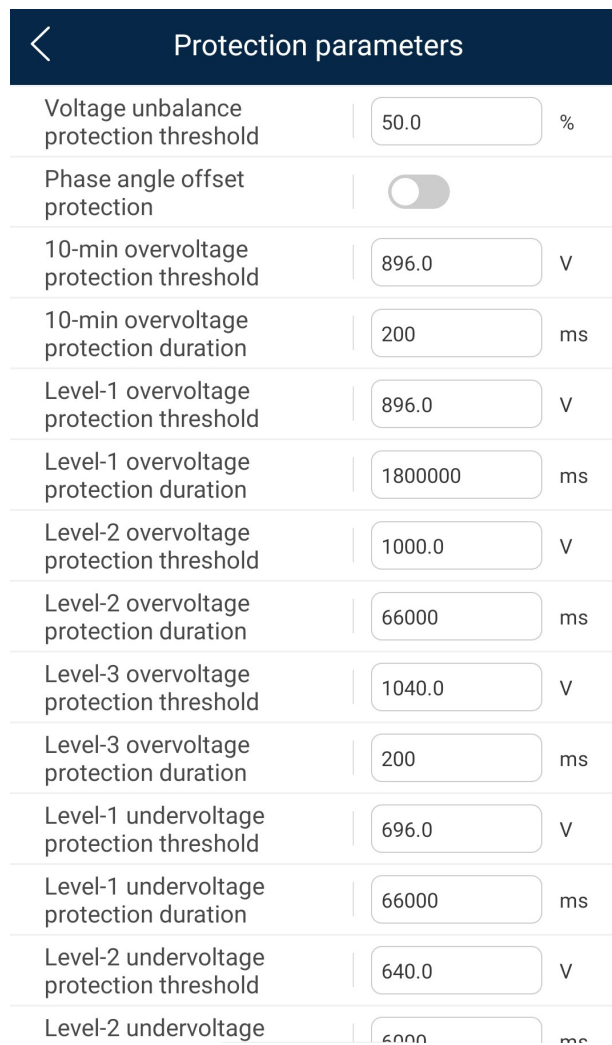

Parameter	Value	Unit
Voltage unbalance protection threshold	50.0	%
Phase angle offset protection	<input type="checkbox"/>	
10-min overvoltage protection threshold	896.0	V
10-min overvoltage protection duration	200	ms
Level-1 overvoltage protection threshold	896.0	V
Level-1 overvoltage protection duration	1800000	ms
Level-2 overvoltage protection threshold	1000.0	V
Level-2 overvoltage protection duration	66000	ms
Level-3 overvoltage protection threshold	1040.0	V
Level-3 overvoltage protection duration	200	ms
Level-1 undervoltage protection threshold	696.0	V
Level-1 undervoltage protection duration	66000	ms
Level-2 undervoltage protection threshold	640.0	V
Level-2 undervoltage protection duration	6000	ms

Table 7-5 Protection parameters

Parameter	Description
Voltage unbalance protection threshold (%)	Specifies the inverter protection threshold when the power grid voltage is unbalanced.

Parameter	Description
Phase angle offset protection	The standards of certain countries and regions require that the inverter needs to be protected when the phase angle offset of the power grid three phases exceeds a certain value.
10-min overvoltage protection threshold (V)	Specifies the 10-minute overvoltage protection threshold.
10-min overvoltage protection duration (ms)	Specifies the 10-minute overvoltage protection duration.
Level-N overvoltage protection threshold (V)	Specifies the level-N grid overvoltage protection threshold. NOTE <ul style="list-style-type: none"> N can be 1, 2, 3, or 4. When HVRT is set to Enable and Level-1 overvoltage protection threshold is higher than Threshold for triggering HVRT, if the grid voltage is between Threshold for triggering HVRT and Level-1 overvoltage protection threshold, the SUN2000 could start and shut down repeatedly.
Level-N overvoltage protection duration (ms)	Specifies the level-N grid overvoltage protection duration. NOTE N can be 1, 2, 3, or 4.
Level-N undervoltage protection threshold (V)	Specifies the level-N grid undervoltage protection threshold. NOTE <ul style="list-style-type: none"> N can be 1, 2, 3, or 4. When LVRT is set to Enable and Level-1 undervoltage protection threshold is lower than Threshold for triggering LVRT, if the grid voltage is between Level-1 undervoltage protection threshold and Threshold for triggering LVRT, the SUN2000 could start and shut down repeatedly.
Level-N undervoltage protection duration (ms)	Specifies the level-N grid undervoltage protection duration. NOTE N can be 1, 2, 3, or 4.
Level-N overfrequency protection threshold (Hz)	Specifies the level-N grid overfrequency protection threshold. NOTE N can be 1 or 2.
Level-N overfrequency protection duration (ms)	Specifies the level-N grid overfrequency protection duration. NOTE N can be 1 or 2.
Level-N underfrequency protection threshold (Hz)	Specifies the level-N grid underfrequency protection threshold. NOTE N can be 1 or 2.
Level-N underfrequency protection duration (ms)	Specifies the level-N grid underfrequency protection duration. NOTE N can be 1 or 2.

----End

7.1.5.3 Setting Feature Parameters

Procedure

Step 1 Choose **Settings > Feature parameters** to set feature parameters.

Figure 7-12 Feature parameters

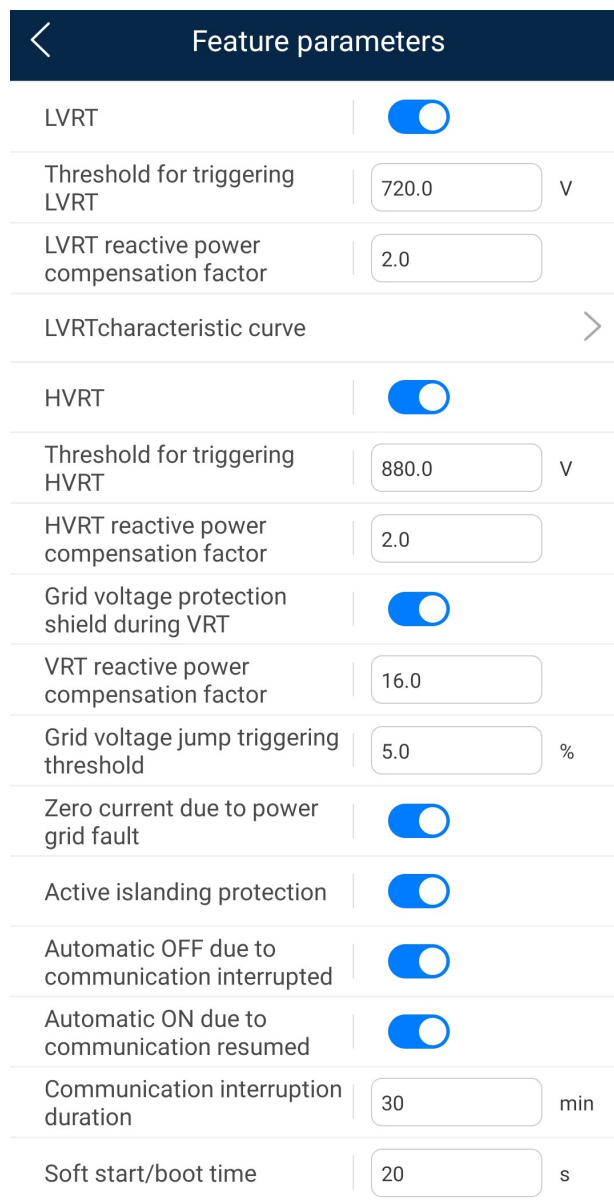

Table 7-6 Feature parameters

Parameter	Description
LVRT	LVRT is short for low voltage ride-through. When the grid voltage is abnormally low for a short time, the inverter cannot disconnect from the power grid immediately and has to work for some time.

Parameter	Description
Threshold for triggering LVRT (V)	Specifies the threshold for triggering LVRT. The threshold settings should meet the local grid standard. This parameter is displayed when LVRT is set to Enable .
LVRT reactive power compensation factor	During LVRT, the inverter needs to generate reactive power to support the power grid. This parameter is used to set the reactive power generated by the inverter. <ul style="list-style-type: none"> This parameter is displayed when LVRT is set to Enable. For example, if this parameter is set to 2, the reactive power generated by the inverter is 20% of the rated power when the AC voltage drops by 10% during LVRT.
HVRT	HVRT is short for high voltage ride-through. When the grid voltage is abnormally high for a short time, the inverter cannot disconnect from the power grid immediately and has to work for some time.
Threshold for triggering HVRT (V)	Specifies the threshold for triggering HVRT. The threshold settings should meet the local grid standard. This parameter is displayed when HVRT is set to Enable .
HVRT reactive power compensation factor	During HVRT, the inverter needs to generate reactive power to support the power grid. This parameter is used to set the reactive power generated by the inverter. This parameter is displayed when HVRT is set to Enable .
Grid voltage protection shield during VRT	Specifies whether to shield the undervoltage protection function during LVRT or HVRT. This parameter is displayed when LVRT or HVRT is set to Enable .
VRT exit hysteresis threshold	Specifies the LVRT/HVRT recovery threshold. <ul style="list-style-type: none"> This parameter is displayed when LVRT or HVRT is set to Enable. LVRT recovery threshold = Threshold for triggering LVRT + VRT exit hysteresis threshold HVRT recovery threshold = Threshold for triggering HVRT - VRT exit hysteresis threshold
Grid voltage jump triggering threshold (%)	Specifies the LVRT or HVRT threshold for triggering a transient voltage jump of a power grid. A transient voltage jump indicates that the inverter cannot immediately disconnect from the power grid when the power grid is abnormal due to transient changes.
Zero current due to power grid fault	Certain countries and regions have requirements on the output current during high/low voltage ride-through. In this case, set this parameter to Enable . After this parameter is set to Enable , the output current is less than 10% of the rated current during high/low voltage ride-through. This parameter is displayed when LVRT or HVRT is set to Enable .

Parameter	Description
Active islanding protection	Specifies whether to enable the active islanding protection function.
Voltage rise suppression	The standards of certain countries and regions require that when the output voltage exceeds a certain value, the inverter must suppress voltage rise by outputting reactive power and reducing active power.
Voltage rise suppressing reactive power adjustment point (%)	The standards of certain countries and regions require that the inverter generate a certain amount of reactive power when the output voltage exceeds a certain value. This parameter is displayed when Voltage rise suppression is set to Enable .
Voltage rise suppressing active power derating point (%)	The standards of certain countries and regions require that the active power of the inverter be derated according to a certain slope when the output voltage exceeds a certain value. <ul style="list-style-type: none"> This parameter is displayed when Voltage rise suppression is set to Enable. The value of Voltage rise suppressing active power derating point must be greater than that of Voltage rise suppressing reactive power adjustment point.
Automatic OFF due to communication interrupted	The standards of certain countries and regions require that the inverter must shut down after the communication is interrupted for a certain time.
Automatic ON due to communication resumed	If this parameter is set to Enable , the inverter automatically starts after communication recovers. If this parameter is set to Disable , the inverter needs to be started manually after communication recovers.
Communication interruption duration (min)	Specifies the duration for determining communication interruption. Used for automatic shutdown for protection in case of communication interruption.
Soft start/boot time (s)	Specifies the duration for the power to gradually increase when the inverter starts.
Soft start time after grid failure (s)	Specifies the time for the power to gradually increase when the inverter restarts after the power grid recovers.

----End

7.1.5.4 Setting Power Adjustment Parameters

Procedure

Step 1 Choose **Settings > Power adjustment** to set power adjustment parameters.

Figure 7-13 Power adjustment parameters

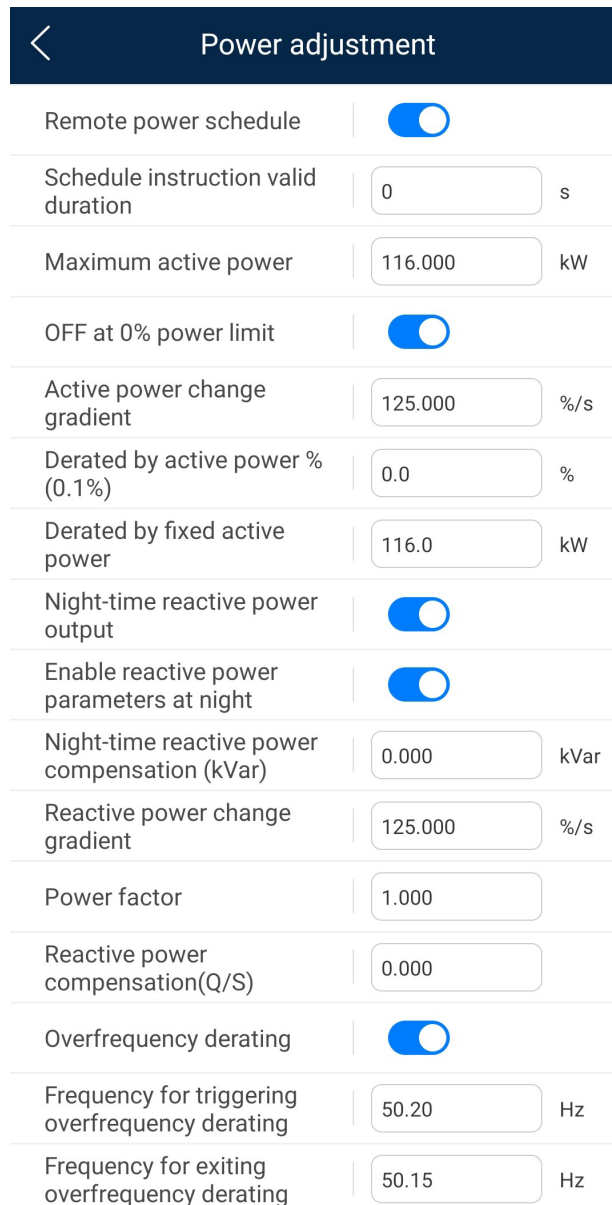

Parameter	Value	Unit
Remote power schedule	<input checked="" type="checkbox"/>	
Schedule instruction valid duration	0	s
Maximum active power	116.000	kW
OFF at 0% power limit	<input checked="" type="checkbox"/>	
Active power change gradient	125.000	%/s
Derated by active power % (0.1%)	0.0	%
Derated by fixed active power	116.0	kW
Night-time reactive power output	<input checked="" type="checkbox"/>	
Enable reactive power parameters at night	<input checked="" type="checkbox"/>	
Night-time reactive power compensation (kVar)	0.000	kVar
Reactive power change gradient	125.000	%/s
Power factor	1.000	
Reactive power compensation(Q/S)	0.000	
Overfrequency derating	<input checked="" type="checkbox"/>	
Frequency for triggering overfrequency derating	50.20	Hz
Frequency for exiting overfrequency derating	50.15	Hz

Table 7-7 Power adjustment parameters

Parameter	Description
Remote power schedule	If this parameter is set to Enable , the inverter responds to the scheduling instruction from the remote port. If this parameter is set to Disable , the inverter does not respond to the scheduling instruction from the remote port.
Schedule instruction valid duration (s)	Specifies the time for maintaining the scheduling instruction. When this parameter is set to 0, the scheduling instruction takes effect permanently.

Parameter	Description
Maximum apparent power (kVA)	Specifies the output upper threshold for the maximum apparent power to adapt to the capacity requirements of standard and customized inverters. If the maximum active power equals the value of Smax_limit, this parameter is not displayed.
Maximum active power (kW)	Specifies the output upper threshold for the maximum active power to adapt to different market requirements.
OFF at 0% power limit	If this parameter is set to Enable , the inverter shuts down after receiving the 0% power limit command. If this parameter is set to Disable , the inverter does not shut down after receiving the 0% power limit command.
Active power change gradient (%/s)	Specifies the change speed of the inverter active power.
Derated by fixed active power (kW)	Adjusts the active power output of the inverter by fixed value. This parameter is displayed if Remote power schedule is set to Enable .
Derated by active power % (%)	Adjusts the active power output of the inverter by percentage. This parameter is displayed if Remote power schedule is set to Enable . If this parameter is set to 100 , the inverter outputs based on the maximum output power.
Night-time reactive power output	In some specific application scenarios, a power grid company requires that the inverter can perform reactive power compensation at night to ensure that the power factor of the local power grid meets requirements. This parameter is displayed when Isolation settings is set to Input ungrounded, with TF .
Enable reactive power parameters at night	When this parameter is set to Enable , the inverter outputs reactive power based on the setting of Reactive power compensation at night . Otherwise, the inverter executes the remote scheduling command. This parameter is displayed when Night-time reactive power output is set to Enable .
Night-time reactive power compensation (kVar)	During the reactive power compensation at night, the reactive power is scheduled by fixed value. This parameter is displayed when Night-time reactive power output and Enable reactive power parameters at night are set to Enable .
Reactive power change gradient (%/s)	Specifies the change speed of the inverter reactive power.

Parameter	Description
Power factor	Specifies the power factor of the inverter. This parameter is displayed if Remote power schedule is set to Enable .
Reactive power compensation (Q/S)	Specifies the reactive power output by the inverter. This parameter is displayed if Remote power schedule is set to Enable .
Overfrequency derating	If this parameter is set to Enable , the active power of the inverter will be derated according to a certain slope when the grid frequency exceeds the frequency that triggers overfrequency derating.
Frequency for triggering overfrequency derating (Hz)	The standards of certain countries and regions require that the output active power of inverters be derated when the power grid frequency exceeds a certain value. This parameter is displayed when Overfrequency derating is set to Enable .
Frequency for exiting overfrequency derating (Hz)	Specifies the frequency threshold for exiting overfrequency derating. This parameter is displayed when Overfrequency derating is set to Enable .
Cutoff frequency of overfrequency derating (Hz)	Specifies the frequency threshold for cutting off overfrequency derating. <ul style="list-style-type: none"> This parameter is displayed when Overfrequency derating is set to Enable. When setting this parameter, ensure that the following condition is met: Frequency for exiting overfrequency derating ≤ Frequency for triggering overfrequency derating < Cutoff frequency of overfrequency derating.
Cutoff power of overfrequency derating (%)	Specifies the power threshold for cutting off overfrequency derating. This parameter is displayed when Overfrequency derating is set to Enable .
Power recovery gradient of overfrequency derating (%/min)	Specifies the recovery rate of the overfrequency derating power. This parameter is displayed when Overfrequency derating is set to Enable .
PF (U) voltage detection filtering time (s)	Specifies the time for filtering the grid voltage in the PF-U curve.
Apparent power baseline (kVA)	Adjust the apparent output baseline of the inverter.
Active power baseline (kW)	Adjusts the active output baseline of the inverter.

Parameter	Description
Communication disconnection fail-safe	In the inverter export limitation scenario, if this parameter is set to Enable , the inverter will perform active power derating by percentage when the communication between the inverter and the SmartLogger or Smart Dongle is disconnected for more than the time specified by Communication disconnection detection time .
Communication disconnection detection time (s)	Specifies the fail-safe detection time for the disconnection between the inverter and the SmartLogger or Smart Dongle.
Active power output limit for fail-safe (%)	Specifies the derating value of the inverter active power by percentage.
Underfrequency rise power	The standards of certain countries and regions require that if the power grid frequency is lower than Frequency for triggering of underfrequency rise power , the inverter needs to increase the active power output to help increase the power grid frequency. In this case, set this parameter to Enable .
Frequency for triggering of underfrequency rise power (Hz)	Specifies the frequency threshold of Underfrequency rise power . This parameter is displayed when Underfrequency rise power is set to Enable .
Power recovery gradient of underfrequency rise (%/min)	Specifies the recovery rate of Underfrequency rise power . This parameter is displayed when Underfrequency rise power is set to Enable .
Cutoff frequency of underfrequency rise power (Hz)	Specifies the cutoff frequency of Underfrequency rise power . This parameter is displayed when Underfrequency rise power is set to Enable .
Cutoff power of underfrequency rise power (%)	Specifies the cutoff power of Underfrequency rise power . This parameter is displayed when Underfrequency rise power is set to Enable .
Frequency for exiting of underfrequency rise power (Hz)	Specifies the exit frequency of Underfrequency rise power . This parameter is displayed when Underfrequency rise power is set to Enable .
Q-U characteristic curve mode	Specifies the reactive power compensation mode of the inverter output.
Power percentage for triggering Q-U scheduling	Specifies the reference apparent power, in percentage. When the actual apparent power of the inverter is greater than the value of this parameter, the Q-U characteristic curve scheduling function is enabled.

Parameter	Description
Q-U characteristic curve	The inverter adjusts Q/S (the ratio of the output reactive power to apparent power) in real time based on U/Un(%) (the ratio of the actual power grid voltage to the rated power grid voltage).
Q-P characteristic curve	The inverter adjusts Q/Pn (the ratio of the output reactive power to the rated active power) in real time based on P/Pn(%) (the ratio of the actual active power to the rated active power).
Cosφ-P/Pn characteristic curve	The inverter adjusts the output power factor cosφ in real time based on P/Pn(%) .

----End

7.2 Operations with a USB Flash Drive

USB flash drives of SanDisk, Netac, or Kingston are supported. Other USB flash drives may not be identified because they are not tested for compatibility.

NOTE

Delete the script file immediately after use to reduce information disclosure risks.

7.2.1 Exporting Configurations

Procedure

1. Click **Local maintenance script** on the app to generate a boot script file, see the *FusionSolar APP and SUN2000 APP User Manual*.
2. Import the boot script file to a PC.
(Optional) The boot script file can be opened as a .txt file.

Figure 7-14 Boot script file

```

1 — User engineer
2 — psw 7e7bc842b22a991d864faecabe20424f79b3e1977286decaa5ae8753d57eae7f
3 — validity duration xxxx-12-31 23:59:59
4 — export param

```

No.	Meaning	Remarks
1	User name	<ul style="list-style-type: none"> Advanced user: engineer Special user: admin
2	Ciphertext	The ciphertext varies depending on the login password of the SUN2000 app or entering the Device Commissioning screen on the FusionSolar app.
3	Script validity period	-
4	Command	Different command settings can produce different commands. <ul style="list-style-type: none"> Configuration export command: export param. Configuration import command: import param. Data export command: export log. Upgrade command: upgrade.

- Import the boot script file to the root directory of a USB flash drive.
- Connect the USB flash drive to the USB port. The system automatically identifies the USB flash drive and executes all commands specified in the boot script file. View the LED indicator to determine the operating status.

NOTICE

Ensure that the ciphertext in the boot script matches the login password for logging in to the SUN2000 app or entering the Device Commissioning screen on the FusionSolar app. Otherwise, the user account will be locked for 10 minutes after the USB flash drive is inserted for five consecutive times.

Table 7-8 LED indicator description

LED Indicator	Status	Meaning
	Green off	There is no operation with a USB flash drive.
	Blinking green slowly	There is an operation with a USB flash drive.
	Blinking green fast	An operation with a USB flash drive has failed.
	Steady green	An operation with a USB flash drive is successful.

5. Insert the USB flash drive into a computer and check the exported data.

 **NOTE**

When the configuration export is complete, the boot script file and exported file are in the root directory of the USB flash drive.

7.2.2 Importing Configurations

Prerequisites

A complete configuration file has been exported.

Procedure

1. Click **Local maintenance script** on the app to generate a boot script file, see the *FusionSolar APP and SUN2000 APP User Manual*.
2. Import the boot script file to a PC.
3. Replace the exported boot script file in the root directory of the USB flash drive with the imported one.

NOTICE

Replace the boot script file only and keep the exported files.

4. Connect the USB flash drive to the USB port. The system automatically identifies the USB flash drive and executes all commands specified in the boot script file. View the LED indicator to determine the operating status.

NOTICE

Ensure that the ciphertext in the boot script matches the login password for logging in to the SUN2000 app or entering the Device Commissioning screen on the FusionSolar app. Otherwise, the user account will be locked for 10 minutes after the USB flash drive is inserted for five consecutive times.

Table 7-9 LED indicator description

LED Indicator	Status	Meaning
	Green off	There is no operation with a USB flash drive.
	Blinking green slowly	There is an operation with a USB flash drive.
	Blinking green fast	An operation with a USB flash drive has failed.
	Steady green	An operation with a USB flash drive is successful.

7.2.3 Exporting Data

Procedure

1. Click **Local maintenance script** on the app to generate a boot script file, see the *FusionSolar APP and SUN2000 APP User Manual*.
2. Import the boot script file to the root directory of a USB flash drive.
3. Connect the USB flash drive to the USB port. The system automatically identifies the USB flash drive and executes all commands specified in the boot script file. View the LED indicator to determine the operating status.

NOTICE

Ensure that the ciphertext in the boot script matches the login password for logging in to the SUN2000 app or entering the Device Commissioning screen on the FusionSolar app. Otherwise, the user account will be locked for 10 minutes after the USB flash drive is inserted for five consecutive times.

Table 7-10 LED indicator description

LED Indicator	Status	Meaning
	Green off	There is no operation with a USB flash drive.
	Blinking green slowly	There is an operation with a USB flash drive.
	Blinking green fast	An operation with a USB flash drive has failed.
	Steady green	An operation with a USB flash drive is successful.

7.2.4 Upgrading

Procedure

1. Download the required software upgrade package from the technical support website.
2. Decompress the upgrade package.

 **NOTE**

If the login password for logging in to the SUN2000 app or entering the **Device Commissioning** screen on the FusionSolar app is the initial password, you do not need to perform steps 3 to 5. If not, perform steps 3 to 7.

3. Click **Local maintenance script** on the app to generate a boot script file, see the *FusionSolar APP and SUN2000 APP User Manual*.
4. Import the boot script file to a PC.
5. Replace the boot script file (sun_lmt_mgr_cmd.emap) in the upgrade package with the one generated by the app.
6. Copy the extracted files to the root directory of the USB flash drive.
7. Connect the USB flash drive to the USB port. The system automatically identifies the USB flash drive and executes all commands specified in the boot script file. View the LED indicator to determine the operating status.

NOTICE

Ensure that the ciphertext in the boot script matches the login password for logging in to the SUN2000 app or entering the Device Commissioning screen on the FusionSolar app. Otherwise, the user account will be locked for 10 minutes after the USB flash drive is inserted for five consecutive times.

Table 7-11 LED indicator description

LED Indicator	Status	Meaning
	Green off	There is no operation with a USB flash drive.
	Blinking green slowly	There is an operation with a USB flash drive.
	Blinking green fast	An operation with a USB flash drive has failed.
	Steady green	An operation with a USB flash drive is successful.

8. The system automatically restarts when the upgrade is completed. All LED indicators are off during the restart. After the restart, the indicator is blinking green slowly for 1 minute and then it becomes steady green, which indicates that the upgrade is successful.

8 Maintenance

Prerequisites

 **DANGER**

- Wear personal protective equipment and use dedicated insulated tools to avoid electric shocks or short circuits.
-

 **WARNING**

- Before performing maintenance, power off the equipment, follow the instructions on the delayed discharge label, and wait for a period of time as specified to ensure that the equipment is not energized.
-

8.1 Powering Off the SUN2000

Context

 **WARNING**

- If two SUN2000s share the same AC switch on the AC side, power off the two SUN2000s.
 - After the SUN2000 powers off, the remaining electricity and heat may still cause electric shocks and body burns. Therefore, put on protective gloves and begin servicing the SUN2000 15 minutes after the power-off.
-

Procedure

- Step 1** Run a shutdown command on the app, SmartLogger, or NMS.

For details, see [7 Man-Machine Interactions](#), or the SmartLogger or NMS user manual.

Step 2 Turn off the AC switch between the SUN2000 and the power grid.

Step 3 Set all DC switches to OFF.

 **NOTE**

For the SUN2000-90KTL-H2 used in Australia, install the delivered screw for locking each DC switch.

----End

8.2 Power-Off for Troubleshooting

Context

To prevent personal injury and equipment damage, perform the following procedure to power off the solar inverter for troubleshooting or replacement.

 **CAUTION**

- When a solar inverter is faulty, try to avoid standing in front of the solar inverter.
 - Do not operate the DC switch on the solar inverter before you finish [Step 3](#) to [Step 5](#).
 - If the AC switch between the solar inverter and the power grid has automatically disconnected, do not turn on the switch before the fault is rectified.
 - Before power-off for troubleshooting, do not touch the energized components of the solar inverter. Otherwise, electric shocks or arcing may occur.
-

Procedure

Step 1 Wear proper personal protective equipment (PPE).

Step 2 If the solar inverter is not shut down due to a fault, send a shutdown command on the SUN2000 app, SmartLogger, or management system. If the solar inverter has shut down due to a fault, go to the next step.

Step 3 Turn off the AC switch between the solar inverter and the power grid.

Step 4 Measure the DC current of each PV input string using a clamp meter that is set to the DC position.

- If the current is less than or equal to 0.5 A, go to the next step.
- If the current is higher than 0.5 A, wait until the solar irradiance decreases and the PV string current decreases below 0.5 A at night, and then go to the next step.

- Step 5** Open the maintenance compartment door, install a support bar, and use a multimeter to measure the voltage between the AC terminal block and the ground. Ensure that the AC side of the solar inverter is disconnected.
- Step 6** Turn off all DC input switches of the solar inverter.
- Step 7** Wait for 15 minutes and troubleshoot or repair the inverter.

WARNING

- Do not open the host panel for maintenance if the solar inverter is emitting odor or smoke, or has obvious exceptions.
 - If the solar inverter does not emit odor or smoke and is intact, repair or restart it based on the alarm handling suggestions. Do not stand in front of the solar inverter during the restart.
-

----End

8.3 Routine Maintenance

To ensure that the SUN2000 can operate properly for a long term, you are advised to perform routine maintenance on it as described in this chapter.

CAUTION

- Before cleaning the system, and maintaining the cable connections and grounding reliability, power off the system (see [8.1 Powering Off the SUN2000](#)) and ensure that the two DC switches on the SUN2000 are OFF.
 - If you need to open the maintenance compartment door in rainy or snowy days, take protective measures to prevent rain and snow entering the maintenance compartment. If it is impossible to take protective measures, do not open the maintenance compartment door in rainy or snowy days.
-

Table 8-1 Maintenance list

Item	Check Method	Maintenance Interval
System cleanliness	Check periodically that the heat sinks are free from obstacles or dust.	Once six months to a year

Item	Check Method	Maintenance Interval
System running status	<ul style="list-style-type: none"> • Check that the SUN2000 is not damaged or deformed. • Check that the running sound of the SUN2000 is normal. • When the SUN2000 is running, check that all SUN2000 parameters are correctly set. 	Once six months
Cable connections	<ul style="list-style-type: none"> • Check that cables are securely connected. • If clamps are used for AC cable connections, check that they are secured with a torque of 35 N·m. • Check that cables are intact, in particular, the parts touching the metallic surface are not scratched. • Check whether the sealing caps of idle DC input terminals fall off. • Check that the cover on the USB port is tightened. • Check that idle RESERVE and COM waterproof connectors are plugged and the locking caps are tightened. 	The first inspection is half a year after the initial commissioning. From then on, perform the inspection once six months to a year.
Grounding reliability	Check that ground cables are securely connected.	The first inspection is half a year after the initial commissioning. From then on, perform the inspection once six months to a year.

8.4 Alarm Reference

For details about alarms, see [Inverter Alarm Reference](#).

9 Handling the Inverter

9.1 Removing the SUN2000

NOTICE

Before removing the SUN2000, disconnect both AC and DC connections.

Perform the following operations to remove the SUN2000:

1. Disconnect all cables from the SUN2000, including RS485 communications cables, DC input power cables, AC output power cables, and PGND cables.
2. Remove the SUN2000 from the mounting bracket.
3. Remove the mounting bracket.

9.2 Packing the SUN2000

- If the original packing materials are available, put the SUN2000 inside them and then seal them by using adhesive tape.
- If the original packing materials are not available, put the SUN2000 inside a suitable cardboard box and seal it properly.

9.3 Disposing of the SUN2000

If the SUN2000 service life expires, dispose of it according to the local disposal rules for electrical equipment waste.

10 Technical Data

10.1 SUN2000-(90KTL, 95KTL) Series Technical Data

Efficiency

Item	SUN2000-90 KTL-H0	SUN2000-90 KTL-H1	SUN2000-90 KTL-H2	SUN2000-95 KTL-INH0	SUN2000-95 KTL-INH1
Maximum efficiency	99.00%				
Chinese efficiency	-	-	-	-	-
EU efficiency	98.80%	98.80%	98.80%	98.80%	98.80%

Input

Item	SUN2000-90K TL-H0	SUN2000-90K TL-H1	SUN2000-90K TL-H2	SUN2000-95K TL-INH0	SUN2000-95K TL-INH1
Maximum input power	102,000 W	102,000 W	102,000 W	102,000 W	112,200 W
Maximum input voltage	1500 V	1500 V	1500 V	1500 V	1500 V
Lowest operating/ startup voltage	600/650 V				
Operating voltage range	600–1500 V				

Item	SUN2000-90K TL-H0	SUN2000-90K TL-H1	SUN2000-90K TL-H2	SUN2000-95K TL-INH0	SUN2000-95K TL-INH1
Full-load MPPT voltage range	880–1300 V				
Rated input voltage	1080 V				
Maximum input current (per MPPT)	22 A	22 A	25 A	22 A	25 A
Maximum short-circuit current (per MPPT)	33 A				
Maximum backfeed current to the PV array	0 A				
Number of inputs	12				
Number of MPP trackers	6				

Output

Item	SUN2000-90 KTL-H0	SUN2000-90 KTL-H1	SUN2000-90 KTL-H2	SUN2000-95 KTL-INH0	SUN2000-95 KTL-INH1
Rated active power	90 kW	90 kW	90 kW	90 kW	90 kW
Maximum apparent power	100 kVA	100 kVA	100 kVA	100 kVA	110 kVA
Maximum active power (cos ϕ = 1)	100 kW	100 kW	100 kW	100 kW	110 kW
Rated output voltage	800 V AC, 3W+PE				
Rated output current	65.0 A	65.0 A	65.0 A	65.0 A	65.0 A

Item	SUN2000-90 KTL-H0	SUN2000-90 KTL-H1	SUN2000-90 KTL-H2	SUN2000-95 KTL-INH0	SUN2000-95 KTL-INH1
Adapted power grid frequency	50/60 Hz				
Maximum output current	72.9 A	72.9 A	72.9 A	72.9 A	80.2 A
Power factor	0.8 leading... 0.8 lagging				
Maximum total harmonic distortion (rated power)	< 3%				

Protection

Item	SUN2000-90 KTL-H0	SUN2000-90 KTL-H1	SUN2000-90 KTL-H2	SUN2000-95 KTL-INH0	SUN2000-95 KTL-INH1
Input DC switch	Supported				
Anti-islanding protection	Supported				
Output overcurrent protection	Supported				
Input reverse connection protection	Supported				
PV string fault detection	Supported				
DC surge protection	Type II				
AC surge protection	Type II				
Insulation resistance detection	Supported				
Residual current monitoring	Supported				

Display and Communication

Item	SUN2000-90 KTL-H0	SUN2000-90 KTL-H1	SUN2000-90 KTL-H2	SUN2000-95 KTL-INH0	SUN2000-95 KTL-INH1
Display	LED indicator, Bluetooth module+app, USB data cable+app, and WLAN module +app				
RS485	Supported				
MBUS	Supported				

Common Parameters

Item	SUN2000-90 KTL-H0	SUN2000-90 KTL-H1	SUN2000-90 KTL-H2	SUN2000-95 KTL-INH0	SUN2000-95 KTL-INH1
Dimensions (W x H x D)	1075 mm x 605 mm x 310 mm				
Net weight	76±1 kg	76±1 kg	79±1 kg	76±1 kg	79±1 kg
Operating temperature	-25°C to +60°C				
Cooling mode	Natural convection				
Highest operating altitude	4000 m				
Operating relative humidity	0%–100% RH				
Input terminal	Amphenol UTX		Amphenol UTX/Staubli MC4 EVO2	Amphenol UTX	
Output terminal	Cable gland + OT/DT terminal				
Overvoltage level	II (DC)/III (AC)				
IP rating	IP65				
Protection level	I				
Pollution degree	III				

10.2 SUN2000-(100KTL, 105KTL) Series Technical Data

Efficiency

Item	SUN2000-100KT L-H0	SUN2000-100KT L-H1	SUN2000-100KT L-H2	SUN2000-105KT L-H1
Maximum efficiency	99.00%			
Chinese efficiency	98.55%	-	98.55%	-
EU efficiency	98.80%	98.80%	98.80%	98.80%

Input

Item	SUN2000-100KT L-H0	SUN2000-100KT L-H1	SUN2000-100KT L-H2	SUN2000-105KT L-H1
Maximum input power	112,200 W	107,100 W	112,200 W	118,400 W
Maximum input voltage	1500 V	1500 V	1500 V	1500 V
Lowest operating/startup voltage	600/650 V			
Operating voltage range	600–1500 V			
Full-load MPPT voltage range	880–1300 V			
Rated input voltage	1080 V			
Maximum input current (per MPPT)	22 A	22 A	25 A	25 A
Maximum short-circuit current (per MPPT)	33 A			
Maximum backfeed current to the PV array	0 A			
Number of inputs	12			

Item	SUN2000-100KT L-H0	SUN2000-100KT L-H1	SUN2000-100KT L-H2	SUN2000-105KT L-H1
Number of MPP trackers	6			

Output

Item	SUN2000-100KT L-H0	SUN2000-100KT L-H1	SUN2000-100KT L-H2	SUN2000-105KT L-H1
Rated active power	100 kW	100 kW	100 kW	105 kW
Maximum apparent power	110 kVA	105 kVA	110 kVA	116 kVA
Maximum active power (cosφ = 1)	110 kW	105 kW	110 kW	116 kW
Rated output voltage	800 V AC, 3W+PE			
Rated output current	72.2 A	72.2 A	72.2 A	75.8 A
Adapted power grid frequency	50 Hz/60 Hz			
Maximum output current	80.2 A	80.2 A	80.2 A	84.6 A
Power factor	0.8 leading... 0.8 lagging			
Maximum total harmonic distortion (rated power)	< 3%			

Protection

Item	SUN2000-100KT L-H0	SUN2000-100KT L-H1	SUN2000-100KT L-H2	SUN2000-105KT L-H1
Input DC switch	Supported			
Anti-islanding protection	Supported			
Output overcurrent protection	Supported			

Item	SUN2000-100KT L-H0	SUN2000-100KT L-H1	SUN2000-100KT L-H2	SUN2000-105KT L-H1
Input reverse connection protection	Supported			
PV string fault detection	Supported			
DC surge protection	Type II			
AC surge protection	Type II			
Insulation resistance detection	Supported			
Residual current monitoring	Supported			

Display and Communication

Item	SUN2000-100KT L-H0	SUN2000-100KT L-H1	SUN2000-100KT L-H2	SUN2000-105KT L-H1
Display	LED indicator, Bluetooth module+app, USB data cable+app, and WLAN module+app			
RS485	Supported			
MBUS	Supported			

Common Parameters

Item	SUN2000-100KT L-H0	SUN2000-100KT L-H1	SUN2000-100KT L-H2	SUN2000-105KT L-H1
Dimensions (W x H x D)	1075 mm x 605 mm x 310 mm			
Net weight	76±1 kg	76±1 kg or 79±1 kg ^a	79±1 kg	79±1 kg
Operating temperature	-25°C to +60°C			
Cooling mode	Natural convection			

Item	SUN2000-100KT L-H0	SUN2000-100KT L-H1	SUN2000-100KT L-H2	SUN2000-105KT L-H1
Highest operating altitude	4000 m			
Operating relative humidity	0%-100% RH			
Input terminal	Amphenol UTX			
Output terminal	Cable gland + OT/DT terminal			
Overvoltage level	II (DC)/III (AC)			
IP rating	IP65			
Protection level	I			
Pollution degree	III			
Note a: The net weight of the SUN2000-100KTL-H1 with the BOM number of 01074282-001 is 79 kg ±1 kg, and that of other BOM numbers is 76 kg ±1 kg.				

A Domain Name List of Management Systems

 NOTE

The list is subject to change.

Table A-1 Domain names of management systems

Domain Name	Data Type	Scenario
intl.fusionsolar.huawei.com	Public IP address	FusionSolar SmartPVMS NOTE The domain name is compatible with cn.fusionsolar.huawei.com (Chinese mainland).

B Grid Codes

Set the correct grid code based on the application area and scenario of the SUN2000.

Table B-1 Grid codes

N o.	Grid Code	Remarks	SUN2000-90KTL-H0	SUN2000-90KTL-H1	SUN2000-90KTL-H2	SUN2000-95KTL - INH0/95KTL-INH1	SUN2000-100KTL-H0/100KTL-H2	SUN2000-100KTL-H1	SUN2000-105KTL-H1
1	CHINA_MV800	China medium-voltage power grid	-	-	-	-	Supported	-	-
2	G59-England-MV800	G59 medium-voltage power grid	-	Supported	Supported	-	-	Supported	Supported
3	AS4777-MV800	Australia medium-voltage power grid	-	Supported	Supported	-	-	-	-
4	INDIA-MV800	India medium-voltage power grid	Supported	Supported	Supported	Supported	-	Supported	Supported

N o.	Grid Code	Remarks	SUN20 00-90 KTL- H0	SUN20 00-90K TL-H1	SUN20 00-90K TL-H2	SUN200 0-95KTL - INH0/95 KTL- INH1	SUN200 0-100K TL- H0/100 KTL-H2	SUN20 00-100 KTL- H1	SUN20 00-105 KTL-H1
5	IEC61727 -MV800	IEC61727 medium- voltage power grid (50 Hz)	Support ed	Support ed	Support ed	Supporte d	-	Support ed	Support ed
6	ABNT NBR 16149- MV800	Brazil medium- voltage power grid	-	-	-	-	-	Support ed	Support ed
7	UTE C 15-712-1 -MV800	France medium- voltage power grid	-	-	-	-	-	Support ed	Support ed
8	Chile- MV800	Chile medium- voltage power grid	-	-	-	-	-	Support ed	Support ed
9	Mexico- MV800	Mexico medium- voltage power grid	-	-	-	-	-	Support ed	Support ed
10	TAI-PEA- MV800	Thailand PEA medium- voltage power grid	-	-	-	-	-	-	Support ed
11	Philippin es- MV800	Philippine s medium- voltage power grid	-	-	-	-	-	-	Support ed

N o.	Grid Code	Remarks	SUN2000-90KTL-H0	SUN2000-90KTL-H1	SUN2000-90KTL-H2	SUN2000-95KTL - INH0/95KTL-INH1	SUN2000-100KTL-H0/100KTL-H2	SUN2000-100KTL-H1	SUN2000-105KTL-H1
12	Malaysia n-MV800	Malaysia medium-voltage power grid	-	Supported	Supported	-	-	-	-
13	SA_RPPs-MV800	South Africa RPPs medium-voltage power grid	-	Supported	Supported	-	-	Supported	Supported
14	Jordan-Transmission-MV800	Jordan power transmission network medium-voltage power grid	-	Supported	Supported	-	-	-	Supported
15	DUBAI-MV800	Dubai medium-voltage power grid	-	Supported	Supported	-	-	Supported	Supported
16	SAUDI-MV800	Saudi Arabia medium-voltage power grid	Supported	Supported	Supported	-	-	-	Supported
17	CLC/TS50549_IE-MV800	Ireland medium-voltage power grid (CLC/TS50549)	-	-	-	-	-	Supported	Supported

N o.	Grid Code	Remarks	SUN2000-90KTL-H0	SUN2000-90KTL-H1	SUN2000-90KTL-H2	SUN2000-95KTL - INH0/95KTL-INH1	SUN2000-100KTL-H0/100KTL-H2	SUN2000-100KTL-H1	SUN2000-105KTL-H1
18	Northern Ireland-MV800	Northern Ireland medium-voltage power grid	-	-	-	-	-	Supported	Supported
19	CEI0-21-MV800	Italy medium-voltage power grid (CEI0-21)	-	-	-	-	-	Supported	Supported
20	IEC 61727-MV800-60Hz	IEC61727 medium-voltage power grid (60 Hz)	Supported	Supported	Supported	Supported	-	Supported	Supported
21	Pakistan-MV800	Pakistan medium-voltage power grid	-	Supported	Supported	-	-	-	-
22	BRASIL-ANEEL-MV800	Brazil medium-voltage power grid	-	-	-	-	-	Supported	Supported
23	EN50438-TR-MV800	Turkey medium-voltage power grid	-	-	-	-	-	Supported	Supported
24	Israel-MV800	Israel medium-voltage power grid	-	Supported	-	-	-	-	Supported

N o.	Grid Code	Remarks	SUN2000-90KTL-H0	SUN2000-90KTL-H1	SUN2000-90KTL-H2	SUN2000-95KTL - INH0/95KTL-INH1	SUN2000-100KTL-H0/100KTL-H2	SUN2000-100KTL-H1	SUN2000-105KTL-H1
25	CEI0-16-MV800	Italy medium-voltage power grid (CEI0-16)	-	Supported	Supported	-	-	Supported	Supported
26	ZAMBIA-MV800	Zambia medium-voltage power grid	-	Supported	Supported	-	-	Supported	Supported
27	KENYA_ETHIOPIA_MV800	Kenya low-voltage and Ethiopia medium-voltage power grid	-	Supported	Supported	-	-	Supported	Supported
28	NAMIBIA_MV800	Namibia medium-voltage power grid	-	Supported	Supported	-	-	Supported	Supported
29	Cameroon-MV800	Cameroon medium-voltage power grid	-	Supported	Supported	-	-	Supported	Supported
30	NIGERIA-MV800	Nigeria medium-voltage power grid	-	Supported	Supported	-	-	Supported	Supported

N o.	Grid Code	Remarks	SUN2000-90KTL-H0	SUN2000-90KTL-H1	SUN2000-90KTL-H2	SUN2000-95KTL - INH0/95KTL-INH1	SUN2000-100KTL-H0/100KTL-H2	SUN2000-100KTL-H1	SUN2000-105KTL-H1
31	ABUDHABI-MV800	Abu Dhabi medium-voltage power grid	-	Supported	Supported	-	-	Supported	Supported
32	LEBANON-MV800	Lebanon medium-voltage power grid	-	Supported	Supported	-	-	Supported	Supported
33	ARGENTINA-MV800	Argentina medium-voltage power grid	-	-	-	-	-	Supported	Supported
34	Jordan-Transmission-HV800	Jordan high-voltage power grid	-	Supported	Supported	-	-	-	Supported
35	TUNISIA-MV800	Tunisia medium-voltage power grid	-	Supported	Supported	-	-	Supported	Supported
36	AUSTRALIA-NER-MV800	Australia NER medium-voltage power grid	-	Supported	Supported	-	-	-	-
37	VDE-AR-N4120_HV800	VDE4120 power grid	Supported	Supported	Supported	Supported	-	Supported	Supported
38	IEEE 1547-MV800	IEEE 1547 power grid	Supported	Supported	Supported	Supported	-	Supported	Supported

N o.	Grid Code	Remarks	SUN2000-90KTL-H0	SUN2000-90KTL-H1	SUN2000-90KTL-H2	SUN2000-95KTL - INH0/95KTL-INH1	SUN2000-100KTL-H0/100KTL-H2	SUN2000-100KTL-H1	SUN2000-105KTL-H1
39	RD1699/661-MV800	Spain medium-voltage power grid (RD1699/661)	-	-	-	-	-	Supported	Supported
40	PO12.3-MV800	Spain medium-voltage power grid (PO12.3)	-	-	-	-	-	Supported	Supported
41	Vietnam-MV800	Vietnam medium-voltage power grid	-	Supported	Supported	-	-	-	Supported
42	CHILE-PMGD-MV800	Chile PMGD medium-voltage power grid	-	-	-	-	-	Supported	Supported
43	GHANA-MV800	Ghana medium-voltage power grid	-	Supported	Supported	-	-	Supported	Supported
44	TAIPOWER-MV800	Taiwan power medium-voltage power grid	-	Supported	Supported	-	-	-	-
45	OMAN-MV800	Oman medium-voltage power grid	-	Supported	Supported	-	-	Supported	Supported

N o.	Grid Code	Remarks	SUN2000-90KTL-H0	SUN2000-90KTL-H1	SUN2000-90KTL-H2	SUN2000-95KTL - INH0/95KTL-INH1	SUN2000-100KTL-H0/100KTL-H2	SUN2000-100KTL-H1	SUN2000-105KTL-H1
46	KUWAIT-MV800	Kuwait medium-voltage power grid	-	Supported	Supported	-	-	Supported	Supported
47	BANGLADESH-MV800	Bangladesh medium-voltage power grid	-	Supported	Supported	-	-	-	-
48	BAHRAIN-MV800	Bahrain medium-voltage power grid	-	Supported	Supported	-	-	Supported	Supported
49	Oman-PDO-MV800	Oman PDO medium-voltage power grid	-	Supported	Supported	-	-	-	-
50	KAZAKHSTAN-MV800	Kazakhstan medium-voltage power grid	-	-	-	-	-	Supported	Supported
51	Mauritius-MV800	Mauritius medium-voltage power grid	-	-	-	-	-	Supported	Supported
52	TAI-MEA-MV800	Thailand MEA medium-voltage power grid	-	-	-	-	-	-	Supported

N o.	Grid Code	Remarks	SUN2000-90KTL-H0	SUN2000-90KTL-H1	SUN2000-90KTL-H2	SUN2000-95KTL - INH0/95KTL-INH1	SUN2000-100KTL-H0/100KTL-H2	SUN2000-100KTL-H1	SUN2000-105KTL-H1
53	PORTUGAL-MV800	Portugal medium-voltage power grid	-	Supported	-	-	-	Supported	-
54	C10/11-MV800	Belgium medium-voltage power grid	-	-	-	-	-	Supported	Supported
55	G99-TYPEB-HV-MV800	UK G99_Type B_HV medium-voltage power grid	-	Supported	Supported	-	-	Supported	Supported
56	G99-TYPEC-HV-MV800	UK G99_Type C_HV medium-voltage power grid	-	Supported	Supported	-	-	Supported	Supported
57	G99-TYPED-MV800	UK G99_Type D medium-voltage power grid	-	Supported	Supported	-	-	Supported	Supported
58	CEA_MV800	India CEA power grid	-	-	-	Supported	-	-	-
59	VDE-AR-N4110-MV800	Germany medium-voltage power grid	-	-	Supported	-	-	Supported	Supported

No.	Grid Code	Remarks	SUN2000-90KTL-H0	SUN2000-90KTL-H1	SUN2000-90KTL-H2	SUN2000-95KTL - INH0/95KTL-INH1	SUN2000-100KTL-H0/100KTL-H2	SUN2000-100KTL-H1	SUN2000-105KTL-H1
60	NTS-MV800	Spain medium-voltage power grid	-	-	-	-	-	Supported	Supported

 **NOTE**

The grid codes are subject to change. The listed codes are for your reference only.

C Contact Information

If you have any questions about this product, please contact us.



<https://digitalpower.huawei.com>

Path: **About Us > Contact Us > Service Hotlines**

To ensure faster and better services, we kindly request your assistance in providing the following information:

- Model
- Serial number (SN)
- Software version
- Alarm ID or name
- Brief description of the fault symptom

 **NOTE**

EU Representative Information: Huawei Technologies Hungary Kft.
Add.: HU-1133 Budapest, Váci út 116-118., 1. Building, 6. floor.
Email: hungary.reception@huawei.com

D Digital Power Customer Service



<https://digitalpower.huawei.com/robotchat/>

E Acronyms and Abbreviations

C

CCO	central controller
CEC	California Energy Commission
CPV	Concentrated Photovoltaics technology

L

LED	light emitting diode
------------	----------------------

M

MPP	maximum power point
MPPT	maximum power point tracking

P

PID	potential induced degradation
PV	photovoltaic

R

RCMU residual current
monitoring unit

W

WEEE waste electrical and
electronic equipment